

**KUTLU
TRUCK**

CATALOGUE

**WHEEL
BOLT & NUT**

index

MERCEDES	06
MAN	20
NEOPLAN	26
CHRYSLER	28
BMC	30
VOLVO	32
IVECO	38
SCANIA	44
BPW	46
DAF	52
DORSE / TRAILER	53
İŞ MAKİNESİ / HEAVY DUTY MACHINES	53
FORD	54
RENAULT	56
ROR	62
SAF	63
MITSUBISHI	68
ISUZU	73
OTOKAR MAGIRUS	80
FAW	81
HINO	81
HOWO	82
KOMATSU	82
KAMAZ	83
MAZ	83
TIR DORSE / SEMI TRAILER	84
DİSK CİVATALARI / DISC BOLTS	88
YTE	89
DONG FENG	90
COBRA	90
TRAKTÖR / TRACTOR	91
FRUEHAUF	92
SOMUN / NUTS	94

MER-2530

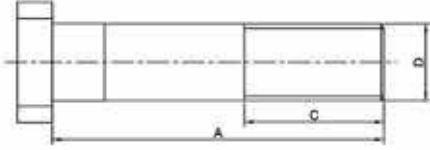

TEKNİK ÖZELLİKLER / TECHNICAL SPECIFICATION			
A(mm)	C (mm)	D (mm)	Kalite / Quality
77	38	22x1.5	10.9
Org. No		305 401 00 71 / 381 401 0171 S1 389 401 00 71 S1 / 327 401 02 71	
Poziyon/ Position		Arka / Rear	
Somun / Wheel Nut		SOM-0342 SOM - 0141	
Model		302	

MER-2531

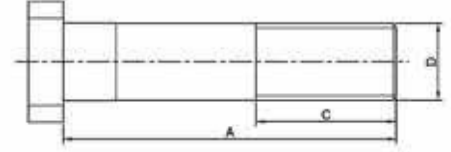

TEKNİK ÖZELLİKLER / TECHNICAL SPECIFICATION			
A(mm)	C (mm)	D (mm)	Kalite / Quality
92	40	22x1.5	10.9
Org. No		3274020471 / 3174020571 / 3814010371	
Poziyon/ Position		Arka / Rear	
Somun / Wheel Nut		SOM - 0342 SOM - 0141	
Model		302	

MER-2532

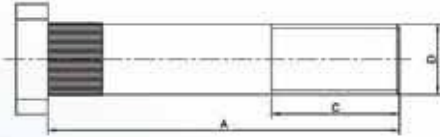

TEKNİK ÖZELLİKLER / TECHNICAL SPECIFICATION			
A(mm)	C (mm)	D (mm)	Kalite / Quality
92	40	22x1.5	10.9
Org. No			
Poziyon/ Position		Arka / Rear FREZELİ / FRAISED	
Somun / Wheel Nut		SOM - 0342 SOM - 0141	
Model		302	

MER-2533

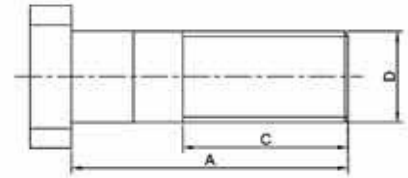

TEKNİK ÖZELLİKLER / TECHNICAL SPECIFICATION			
A(mm)	C (mm)	D (mm)	Kalite / Quality
67	40	22x1.5	10.9
Org. No		338 401 50 71	
Poziyon/ Position		Ön / Front	
Somun / Wheel Nut		SOM-0342 SOM-0141	
Model		0 403	

MER-2534

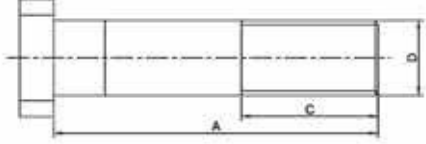

TEKNİK ÖZELLİKLER / TECHNICAL SPECIFICATION			
A(mm)	C (mm)	D (mm)	Kalite / Quality
82	40	22x1.5	10.9
Org. No		389 401 00 71	
Poziyon/ Position		Arka / Rear	
Somun / Wheel Nut		SOM-0342 SOM-0141	
Model		0 403	

MER-2535

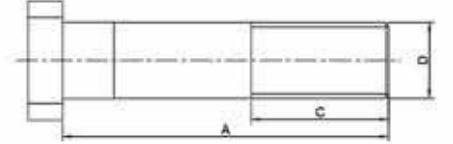

TEKNİK ÖZELLİKLER / TECHNICAL SPECIFICATION			
A(mm)	C (mm)	D (mm)	Kalite / Quality
77	39	20x1.5	10.9
Org. No		3894010071	
Poziyon/ Position		Ön / Front	
Somun / Wheel Nut		SOM-0330 SOM-0130	
Model		352	

MER-2536

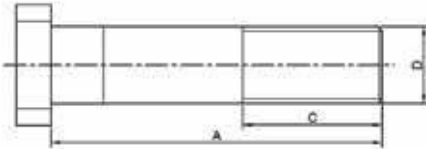

TEKNİK ÖZELLİKLER / TECHNICAL SPECIFICATION			
A(mm)	C (mm)	D (mm)	Kalite / Quality
89	43	20x1.5	10.9
Org. No		327 402 03 71	
Poziyon/ Position		Arka / Rear	
Somun / Wheel Nut		SOM-0330 SOM-130	
Model		352	

MER-2537



TEKNİK ÖZELLİKLER / TECHNICAL SPECIFICATION			
A(mm)	C (mm)	D (mm)	Kalite / Quality
84	38	22x1.5	10.9
Org. No		3814011271	
Poziyon/ Position		Ön / Front	
Somun / Wheel Nut		SOM-0342 SOM-0141	
Model		2517-2521-2524-2622-0305	

MER-2538

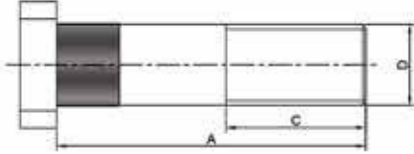

TEKNİK ÖZELLİKLER / TECHNICAL SPECIFICATION			
A(mm)	C (mm)	D (mm)	Kalite / Quality
84	38	22x1.5	10.9
Org. No			
Poziyon/ Position		FREZELİ / FRAISED	
Somun / Wheel Nut		SOM-0342 SOM-0141	
Model		2517-2521-2524-2622-0305 0 307 - 0 405	

MER-2539

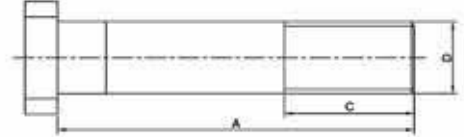

TEKNİK ÖZELLİKLER / TECHNICAL SPECIFICATION			
A(mm)	C (mm)	D (mm)	Kalite / Quality
110	40	22x1.5	10.9
Org. No		3814010771	
Poziyon/ Position		Arka / Rear	
Somun / Wheel Nut		SOM - 0342 SOM - 0141	
Model		2517-2521-2524-2622	

MER-2540



TEKNİK ÖZELLİKLER / TECHNICAL SPECIFICATION			
A(mm)	C (mm)	D (mm)	Kalite / Quality
110	40	22x1.5	10.9
Org. No			
Poziyon/ Position		FREZELİ / FRAISED	
Somun / Wheel Nut		SOM - 0342 SOM - 0141	
Model		2517-2521-2524-2622 NG SK	

MER-2541



TEKNİK ÖZELLİKLER / TECHNICAL SPECIFICATION			
A(mm)	C (mm)	D (mm)	Kalite / Quality
128	45	22x1.5	10.9
Org. No		381 401 1471	
Poziyon/ Position		Arka / Rear	
Somun / Wheel Nut		SOM-0342 - SOM-0141	
Model		2517-2521-ACTROS-ATEGO-AX-OR-CITARO-CONECTO - ECONIC-0305-0303-SK-UNIMOG-VARIO	

MER-2542



TEKNİK ÖZELLİKLER / TECHNICAL SPECIFICATION			
A(mm)	C (mm)	D (mm)	Kalite / Quality
128	45	22x1.5	10.9
Org. No			
Poziyon/ Position		Arka / Rear	
Somun / Wheel Nut		SOM-0342 SOM-0141	
Model		2517-2521	

MER-2543

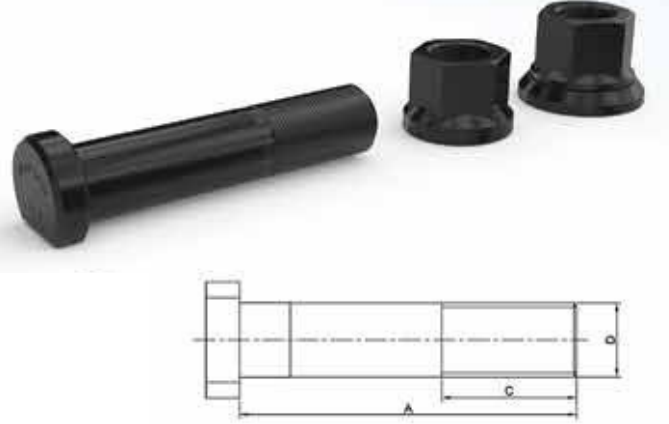

TEKNİK ÖZELLİKLER / TECHNICAL SPECIFICATION			
A(mm)	C (mm)	D (mm)	Kalite / Quality
100	40	22x1.5	10.9
Org. No		381 401 0571 - 381 401 0471 381 401 1171	
Poziyon/ Position		Arka / Rear	
Somun / Wheel Nut		SOM-0342 SOM-0141	
Model		2517-2521-2524-2622-0 307 0 405 - V6 - V8 - 0 303	

MER-2544



TEKNİK ÖZELLİKLER / TECHNICAL SPECIFICATION			
A(mm)	C (mm)	D (mm)	Kalite / Quality
100	40	22x1.5	10.9
Org. No			
Poziyon/ Position		FREZELİ / FRAISED	
Somun / Wheel Nut		SOM-0342 - SOM-0141	
Model		2517-2521-2524-2622-V6-V8 0303	

MER-2545



TEKNİK ÖZELLİKLER / TECHNICAL SPECIFICATION			
A(mm)	C (mm)	D (mm)	Kalite / Quality
77	38	22x1.5	10.9
Org. No		305 401 0071 / 381 401 0171 317 401 0371 / 327 401 0471	
Poziyon/ Position		Ön / Front	
Somun / Wheel Nut		SOM-0342 SOM -0141	
Model		2517-2521-2524-2622 -V6-V8- 0303	

MER-2547

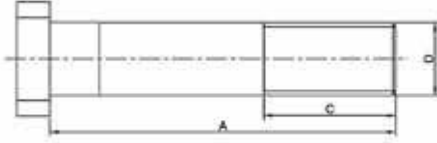

TEKNİK ÖZELLİKLER / TECHNICAL SPECIFICATION

A(mm)	C (mm)	D (mm)	Kalite / Quality
105	40	22x1.5	10.9
Org. No		381 401 0671 - 355 401 0071	
Poziyon/ Position		Arka / Rear	
Somun / Wheel Nut		SOM-0342 SOM-0141	
Model		2517-2521-2524-2622-0 305- 0 307 - 0 405	

MER-2548

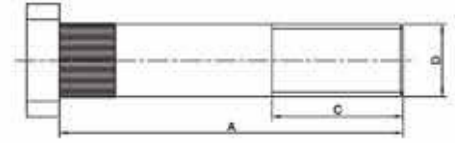

TEKNİK ÖZELLİKLER / TECHNICAL SPECIFICATION

A(mm)	C (mm)	D (mm)	Kalite / Quality
105	40	22x1.5	10.9
Org. No			
Poziyon/ Position		FREZELİ / FRAISED	
Somun / Wheel Nut		SOM-0342 SOM-0141	
Model		2517-2521-2524-2622-0 305 0 307 - 0 405	

MER-2549



TEKNİK ÖZELLİKLER / TECHNICAL SPECIFICATION

A(mm)	C (mm)	D (mm)	Kalite / Quality
70	42	22x1.5	10.9
Org. No		942 401 02 71	
Poziyon/ Position		Ön / Front	
Somun / Wheel Nut		SOM-0140	
Model		AXOR - ACTROS - ATEGO - ECONIC TRAVEGO	

MER-2550



TEKNİK ÖZELLİKLER / TECHNICAL SPECIFICATION

A(mm)	C (mm)	D (mm)	Kalite / Quality
92	60	22x1.5	10.9
Org. No		942 401 03 71	
Poziyon/ Position		Arka / Rear	
Somun / Wheel Nut		SOM-0141	
Model		AXOR - ACTROS -TRAVEGO	

MER-2551

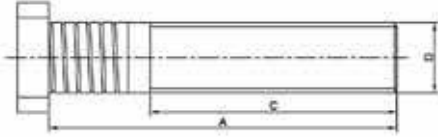

TEKNİK ÖZELLİKLER / TECHNICAL SPECIFICATION

A(mm)	C (mm)	D (mm)	Kalite / Quality
110	78	22x1.5	10.9
Org. No		381 401 01 71	
Poziyon/ Position		Arka / Rear	
Somun / Wheel Nut		SOM-0141	
Model		AXOR - ACTROS	

MER-2552

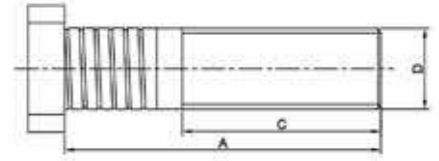

TEKNİK ÖZELLİKLER / TECHNICAL SPECIFICATION

A(mm)	C (mm)	D (mm)	Kalite / Quality
80	55	22x1.5	10.9
Org. No		3894010071	
Poziyon/ Position		Arka / Rear	
Somun / Wheel Nut		SOM-0140	
Model		AXOR - ACTROS	

MER-2553

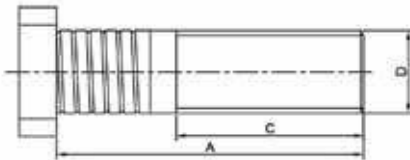

TEKNİK ÖZELLİKLER / TECHNICAL SPECIFICATION

A(mm)	C (mm)	D (mm)	Kalite / Quality
85	50	22x1.5	10.9
Org. No			
Poziyon/ Position		Arka / Rear	
Somun / Wheel Nut		SOM-0140	
Model		ACTROS - AXOR	

MER-2559



TEKNİK ÖZELLİKLER / TECHNICAL SPECIFICATION

A(mm)	C (mm)	D (mm)	Kalite / Quality
70	42.5	22x1.5	10.9
Org. No		0004012371	
Poziyon/ Position		Ön / Front	
Somun / Wheel Nut		SOM-0140	
Model		AXOR - ACTROS - TRAVEGO Y.M.	

MER-2560

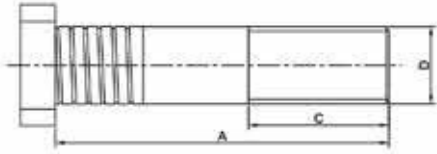

TEKNİK ÖZELLİKLER / TECHNICAL SPECIFICATION

A(mm)	C (mm)	D (mm)	Kalite / Quality
92	56	22x1.5	10.9
Org. No		0004014171	
Poziyon/ Position		Arka / Rear	
Somun / Wheel Nut		SOM-0140	
Model		AXOR - ACTROS TRAVEGO Y.M.	

MER-2561

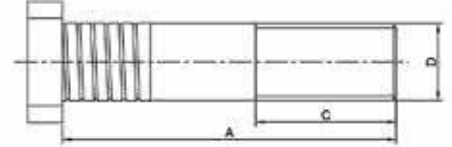

TEKNİK ÖZELLİKLER / TECHNICAL SPECIFICATION

A(mm)	C (mm)	D (mm)	Kalite / Quality
110	76	22x1.5	10.9
Org. No		0004013771	
Poziyon/ Position		Ön / Front	
Somun / Wheel Nut		SOM-0140	
Model		AXOR - ACTROS Y.M.	

MER-2562

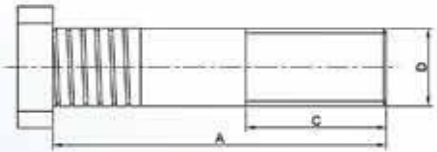

TEKNİK ÖZELLİKLER / TECHNICAL SPECIFICATION

A(mm)	C (mm)	D (mm)	Kalite / Quality
80	49	22x1.5	10.9
Org. No		0004012471	
Poziyon/ Position		Arka / Rear	
Somun / Wheel Nut		SOM-0140	
Model		AXOR - ACTROS - Y.M.	

MER-2563



TEKNİK ÖZELLİKLER / TECHNICAL SPECIFICATION

A(mm)	C (mm)	D (mm)	Kalite / Quality
85	51	22x1.5	10.9
Org. No		0004012971	
Poziyon/ Position		Arka / Rear	
Somun / Wheel Nut		SOM-0140	
Model		AXOR - ACTROS - TRAVEGO Y.M.	

MER-2571

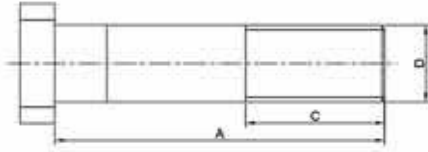

TEKNİK ÖZELLİKLER / TECHNICAL SPECIFICATION

A(mm)	C (mm)	D (mm)	Kalite / Quality
66	38	20x1.5	10.9
Org. No		327 401 00 71 / 312 401 11 71 / 318 402 02 71	
Poziyon/ Position		Arka / Rear	
Somun / Wheel Nut		SOM-0130	
Model		ATEGO 1517	

MER-2572

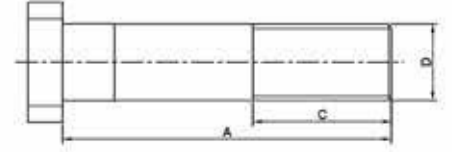

TEKNİK ÖZELLİKLER / TECHNICAL SPECIFICATION

A(mm)	C (mm)	D (mm)	Kalite / Quality
76	43	20x1.5	10.9
Org. No		352 402 00 71	
Poziyon/ Position		Arka / Rear	
Somun / Wheel Nut		SOM-0130	
Model		ATEGO 1517	

MER-2573



TEKNİK ÖZELLİKLER / TECHNICAL SPECIFICATION

A(mm)	C (mm)	D (mm)	Kalite / Quality
100	45	22x1.5	10.9
Org. No			
Poziyon/ Position		Arka / Rear FREZELİ / FRAISED	
Somun / Wheel Nut		SOM-0130	
Model		ATEGO 1517	

MER 2575

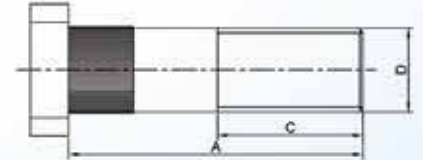

TEKNİK ÖZELLİKLER / TECHNICAL SPECIFICATION

A(mm)	C (mm)	D (mm)	Kalite / Quality
77	38	22x1.5	10.9
Org. No			
Poziyon/ Position		FREZELİ / FRAISED	
Somun / Wheel Nut		SOM - 0342 SOM - 0141	
Model		2517-2521-2524-2622-V8 - V6 - 0303	

MER-2576

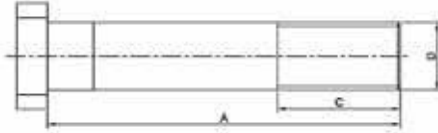

TEKNİK ÖZELLİKLER / TECHNICAL SPECIFICATION

A(mm)	C (mm)	D (mm)	Kalite / Quality
115	40	22x1.5	10.9
Org. No		381 401 0871	
Poziyon/ Position		Arka / Rear	
Somun / Wheel Nut		SOM-0342 SOM-0141	
Model		2517-2521-2524-2622	

MER-2577

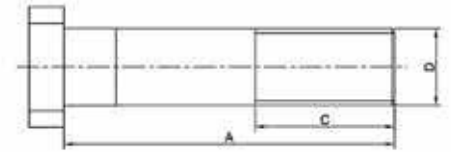

TEKNİK ÖZELLİKLER / TECHNICAL SPECIFICATION

A(mm)	C (mm)	D (mm)	Kalite / Quality
95	40	22x1.5	10.9
Org. No		381 401 1171	
Poziyon/ Position		Arka / Rear	
Somun / Wheel Nut		SOM-0342 SOM-0141	
Model		2517-2521-2524	

MER-2578

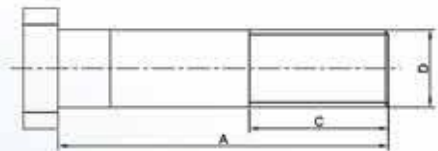

TEKNİK ÖZELLİKLER / TECHNICAL SPECIFICATION

A(mm)	C (mm)	D (mm)	Kalite / Quality
95	40	22x1.5	10.9
Org. No		381 401 1371	
Poziyon/ Position		Arka / Rear	
Somun / Wheel Nut		SOM-0342 SOM-0141	
Model			

MER-2578

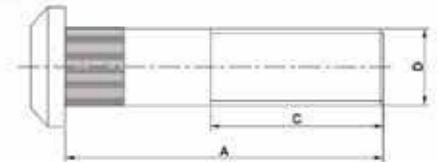

TEKNİK ÖZELLİKLER / TECHNICAL SPECIFICATION

A(mm)	C (mm)	D (mm)	Kalite / Quality
80	50	22x1.5	10.9
Org. No			
Poziyon/ Position		Ön / Front	
Somun / Wheel Nut		SOM-0141	
Model		457	

MER-2579



TEKNİK ÖZELLİKLER / TECHNICAL SPECIFICATION

A(mm)	C (mm)	D (mm)	Kalite / Quality
98	50	22x1.5	10.9
Org. No			
Poziyon/ Position		Arka / Rear	
Somun / Wheel Nut		SOM-0141	
Model		457	

MER-2583

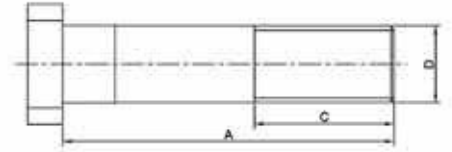

TEKNİK ÖZELLİKLER / TECHNICAL SPECIFICATION

A(mm)	C (mm)	D (mm)	Kalite / Quality
73	38	18x1.5	10.9
Org. No		371 401 70 71	
Poziyon/ Position		Ön / Front	
Somun / Wheel Nut		SOM-0320	
Model		MB 800	

MER-2584

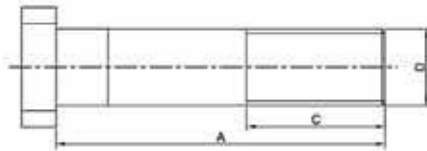

TEKNİK ÖZELLİKLER / TECHNICAL SPECIFICATION

A(mm)	C (mm)	D (mm)	Kalite / Quality
86	50	18x1.5	10.9
Org. No		371 402 70 71	
Poziyon/ Position		Arka / Rear	
Somun / Wheel Nut		SOM-0320	
Model		MB 800	

MER-2590

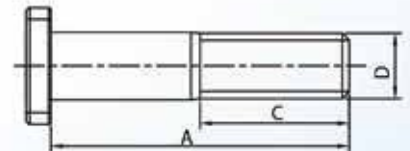

TEKNİK ÖZELLİKLER / TECHNICAL SPECIFICATION

A(mm)	C (mm)	D (mm)	Kalite / Quality
50	30	14x1.5	10.9
Org. No		3094010271	
Poziyon/ Position		Ön / Front	
Somun / Wheel Nut		SOM-0115	
Model		SPRINTER	

MER-2591

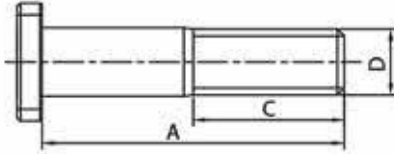

TEKNİK ÖZELLİKLER / TECHNICAL SPECIFICATION			
A(mm)	C (mm)	D (mm)	Kalite / Quality
60	32	14x1.5	10.9
Org. No	3094020271		
Poziyon/ Position	Arka / Rear		
Somun / Wheel Nut	SOM-0115		
Model	SPRINTER		

MER-2592

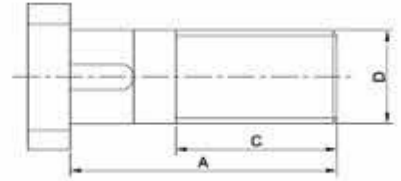

TEKNİK ÖZELLİKLER / TECHNICAL SPECIFICATION			
A(mm)	C (mm)	D (mm)	Kalite / Quality
63	38	2 2x1.5	10.9
Org. No	BQ297638		
Poziyon/ Position			
Somun / Wheel Nut	SOM-0140		
Model	BLUMAQ		

MER-2593

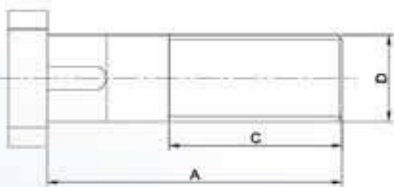

TEKNİK ÖZELLİKLER / TECHNICAL SPECIFICATION			
A(mm)	C (mm)	D (mm)	Kalite / Quality
75	44	22x1.5	10.9
Org. No	BQ297636		
Poziyon/ Position			
Somun / Wheel Nut	SOM-0140		
Model	BLUMAQ		

MER-2594

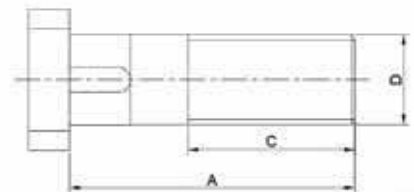

TEKNİK ÖZELLİKLER / TECHNICAL SPECIFICATION			
A(mm)	C (mm)	D (mm)	Kalite / Quality
70	41	22x1.5	10.9
Org. No	BQ297637		
Poziyon/ Position			
Somun / Wheel Nut	SOM-0140		
Model	BLUMAQ		

MER-2595



TEKNİK ÖZELLİKLER / TECHNICAL SPECIFICATION			
A(mm)	C (mm)	D (mm)	Kalite / Quality
90	45	22x1.5	10.9
Org. No		BQ297639	
Poziyon/ Position			
Somun / Wheel Nut		SOM-0140	
Model		BLUMAQ	

MER-2596

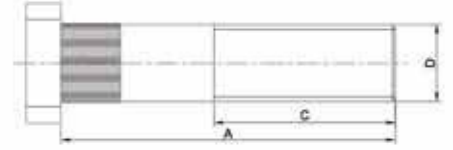

TEKNİK ÖZELLİKLER / TECHNICAL SPECIFICATION			
A(mm)	C (mm)	D (mm)	Kalite / Quality
110	50	22x1.5	10.9
Org. No		BQ304486	
Poziyon/ Position			
Somun / Wheel Nut		SOM-0140	
Model		BLUMAQ	

MER-2597

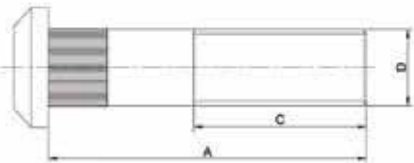

TEKNİK ÖZELLİKLER / TECHNICAL SPECIFICATION			
A(mm)	C (mm)	D (mm)	Kalite / Quality
92	50	22x1.5	10.9
Org. No		BQ3152659	
Poziyon/ Position		Arka / Rear	
Somun / Wheel Nut		SOM-0140	
Model			

MER-2598

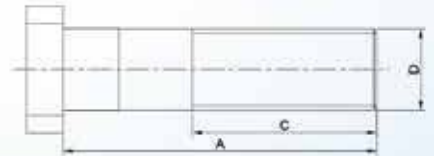

TEKNİK ÖZELLİKLER / TECHNICAL SPECIFICATION			
A(mm)	C (mm)	D (mm)	Kalite / Quality
85	50	22x1.5	10.9
Org. No		BQ103236486	
Poziyon/ Position		Arka / Rear	
Somun / Wheel Nut		SOM-0140	
Model		BLUMAQ	

MN-3150

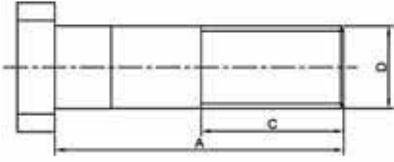

TEKNİK ÖZELLİKLER / TECHNICAL SPECIFICATION

A(mm)	C (mm)	D (mm)	Kalite / Quality
77	38	22x1.5	10.9
Org. No		81 45501 0134 / 81 45501 0076	
Poziyon/ Position		Ön / Front	
Somun / Wheel Nut		SOM-0342 SOM-0141	
Model		F2000 - F90	

MN-3151

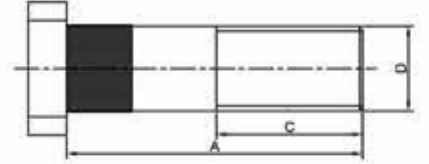

TEKNİK ÖZELLİKLER / TECHNICAL SPECIFICATION

A(mm)	C (mm)	D (mm)	Kalite / Quality
77	38	M22x1.5	10.9
Org. No			
Poziyon/ Position		Ön / Front	
Somun / Wheel Nut		SOM-0342 SOM-0140	
Model		F2000 - F90	

MN-3152



TEKNİK ÖZELLİKLER / TECHNICAL SPECIFICATION

A(mm)	C (mm)	D (mm)	Kalite / Quality
100	40	22x1.5	10.9
Org. No		81 45501 0080 / 81 45501 0072 / 81 45501 0059 / 81 45501 0139	
Poziyon/ Position		Arka / Rear	
Somun / Wheel Nut		SOM-0342 SOM-0141	
Model		F2000 - F90	

MN-3153



TEKNİK ÖZELLİKLER / TECHNICAL SPECIFICATION

A(mm)	C (mm)	D (mm)	Kalite / Quality
100	40	M22x1.5	10.9
Org. No			
Poziyon/ Position		Arka / Rear FREZELİ / FRAISED	
Somun / Wheel Nut		SOM-0342 S*M-0141	
Model		F2000 - F90	

MN-3154

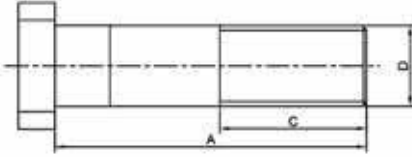

TEKNİK ÖZELLİKLER / TECHNICAL SPECIFICATION

A(mm)	C (mm)	D (mm)	Kalite / Quality
85	40	M22x1.5	10.9
Org. No		81 45501 0085	
Poziyon/ Position		Ön / Front	
Somun / Wheel Nut		SOM-0342 SOM-0141	
Model		F2000 - F90	

MN-3155

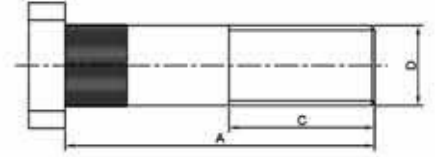

TEKNİK ÖZELLİKLER / TECHNICAL SPECIFICATION

A(mm)	C (mm)	D (mm)	Kalite / Quality
85	40	M22x1.5	10.9
Org. No		81 45501 0085	
Poziyon/ Position		Ön / Front	
Somun / Wheel Nut		SOM-0342 SOM-0141	
Model		F2000 - F90	

MN-3156



TEKNİK ÖZELLİKLER / TECHNICAL SPECIFICATION

A(mm)	C (mm)	D (mm)	Kalite / Quality
110	40	M22x1.5	10.9
Org. No		81 45501 0082 / 81 45501 01 41 / 81 45501 0067	
Poziyon/ Position		Arka / Rear	
Somun / Wheel Nut		SOM-0342 - SOM-0141	
Model		F2000 / F90	

MN-3157

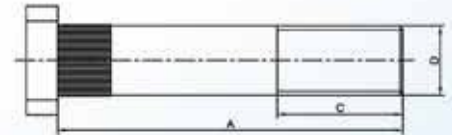

TEKNİK ÖZELLİKLER / TECHNICAL SPECIFICATION

A(mm)	C (mm)	D (mm)	Kalite / Quality
110	40	M22x1.5	10.9
Org. No		81 45501 0082 / 81 45501 01 41 / 81 45501 0067	
Poziyon/ Position		Arka / Rear FREZELİ / FRAISED	
Somun / Wheel Nut		SOM-0342 - SOM*0141	
Model		F2000 - F90	

MN-3160

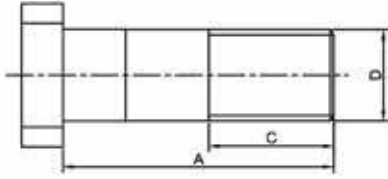

TEKNİK ÖZELLİKLER / TECHNICAL SPECIFICATION

A(mm)	C (mm)	D (mm)	Kalite / Quality
65	30	M22x1.5	10.9
Org. No		81 45501 0132	
Poziyon/ Position		Ön / Front	
Somun / Wheel Nut		SOM-0144 SOM-0140	
Model		FORTUNA	

MN-3161

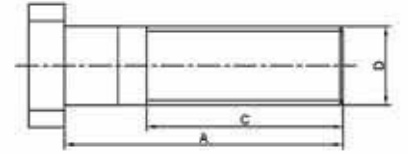

TEKNİK ÖZELLİKLER / TECHNICAL SPECIFICATION

A(mm)	C (mm)	D (mm)	Kalite / Quality
78	55	M22x1.5	10.9
Org. No		81 45501 0765	
Poziyon/ Position		Arka / Rear	
Somun / Wheel Nut		SOM-0145 SOM-0140	
Model		FORTUNA	

MN-3162

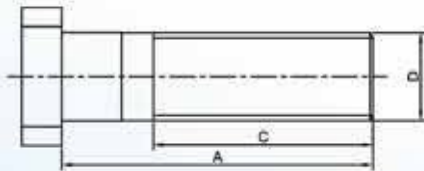

TEKNİK ÖZELLİKLER / TECHNICAL SPECIFICATION

A(mm)	C (mm)	D (mm)	Kalite / Quality
78	55	M22x1.5	10.9
Org. No			
Poziyon/ Position		Arka / Rear	
Somun / Wheel Nut		SOM-0140	
Model		TGA	

MN-3163

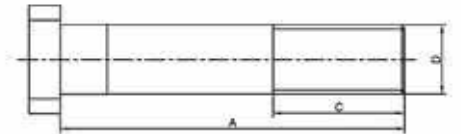

TEKNİK ÖZELLİKLER / TECHNICAL SPECIFICATION

A(mm)	C (mm)	D (mm)	Kalite / Quality
110	38	M22x1.5	10.9
Org. No		81 45501 0176	
Poziyon/ Position		Arka / Rear	
Somun / Wheel Nut		SOM-0141	
Model		TGA	

MN-3164

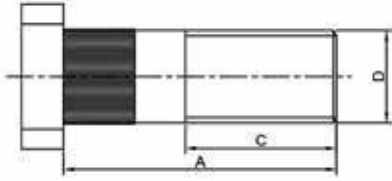

TEKNİK ÖZELLİKLER / TECHNICAL SPECIFICATION

A(mm)	C (mm)	D (mm)	Kalite / Quality
65	36	M22x1.5	10.9
Org. No		81 45501 29	
Poziyon/ Position		Arka / Rear	
Somun / Wheel Nut		AS001 / AS020	
Model		NEOPLAN	

MN-3166



TEKNİK ÖZELLİKLER / TECHNICAL SPECIFICATION

A(mm)	C (mm)	D (mm)	Kalite / Quality
110	41	M22x1.5	10.9
Org. No		81 45501 0176	
Poziyon/ Position		Arka / Rear	
Somun / Wheel Nut		SOM-0141	
Model		T.G.S. TGA	

MN-3165

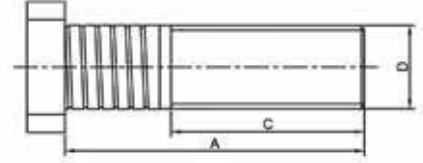

TEKNİK ÖZELLİKLER / TECHNICAL SPECIFICATION

A(mm)	C (mm)	D (mm)	Kalite / Quality
79	50	M22x1.5	10.9
Org. No		85 45501 0174	
Poziyon/ Position		Ön / Front	
Somun / Wheel Nut		SOM-0140	
Model		T.G.S. TGA	

MN-3167

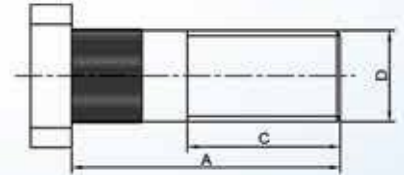

TEKNİK ÖZELLİKLER / TECHNICAL SPECIFICATION

A(mm)	C (mm)	D (mm)	Kalite / Quality
78	45	M22x1.5	10.9
Org. No			
Poziyon/ Position		Ön / Front FREZELİ / FRAISED	
Somun / Wheel Nut		SOM-0140	
Model		TGA	

MN-3169

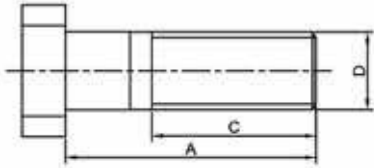

TEKNİK ÖZELLİKLER / TECHNICAL SPECIFICATION

A(mm)	C (mm)	D (mm)	Kalite / Quality
58	38	M18x1.5	10.9
Org. No		81 45501 0116	
Poziyon/ Position		Ön / Front	
Somun / Wheel Nut		SOM-0120	
Model		12.153	

MN-3170

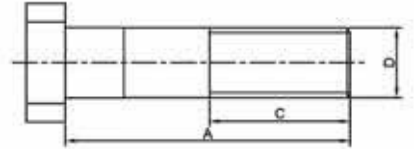

TEKNİK ÖZELLİKLER / TECHNICAL SPECIFICATION

A(mm)	C (mm)	D (mm)	Kalite / Quality
73	36	M18x1.5	10.9
Org. No		81 45501 0123	
Poziyon/ Position		Arka / Rear	
Somun / Wheel Nut		SOM-0120	
Model		13.153	

MN-3171



TEKNİK ÖZELLİKLER / TECHNICAL SPECIFICATION

A(mm)	C (mm)	D (mm)	Kalite / Quality
90	45	M20x1.5	10.9
Org. No			
Poziyon/ Position		Arka / Rear	
Somun / Wheel Nut		SOM-0130	
Model		12.153	

MN-3191

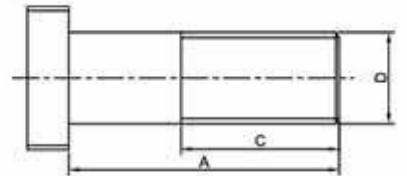

TEKNİK ÖZELLİKLER / TECHNICAL SPECIFICATION

A(mm)	C (mm)	D (mm)	Kalite / Quality
65	38	M18X2	10.9
Org. No		612112451	
Poziyon/ Position		--	
Somun / Wheel Nut		SOM-0322	
Model			

MN-3192

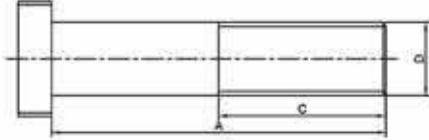

TEKNİK ÖZELLİKLER / TECHNICAL SPECIFICATION

A(mm)	C (mm)	D (mm)	Kalite / Quality
110	50	M18x2	10.9
Org. No	81 45422 0009 / 81454220040 / 3044020270 / 3154020070 / 3874010270 / 0140962 / 0228634		
Poziyon/ Position	--		
Somun / Wheel Nut	SOM-0322		
Model			

MN-3194

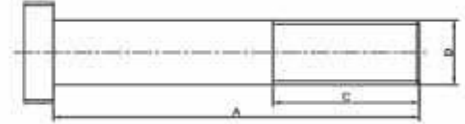

TEKNİK ÖZELLİKLER / TECHNICAL SPECIFICATION

A(mm)	C (mm)	D (mm)	Kalite / Quality
125	50	M18x2	10.9
Org. No	659112456 / 81454220023 / 81454220037 / 3154020170 / 3464025070 / 0250702100 / 0250704400		
Poziyon/ Position			
Somun / Wheel Nut	SOM-0322		
Model			

MN-3195

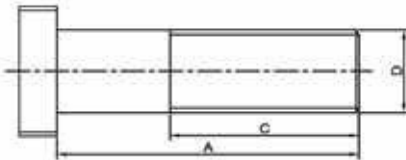

TEKNİK ÖZELLİKLER / TECHNICAL SPECIFICATION

A(mm)	C (mm)	D (mm)	Kalite / Quality
80	50	M18X2	10.9
Org. No	659112452		
Poziyon/ Position	--		
Somun / Wheel Nut	SOM-0322		
Model			

MN-3196

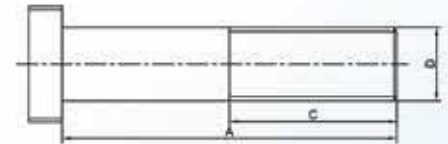

TEKNİK ÖZELLİKLER / TECHNICAL SPECIFICATION

A(mm)	C (mm)	D (mm)	Kalite / Quality
100	50	M18x2	10.9
Org. No	3154020270 / 3874020070 / 81454220036 / 81454220024 / 0250702500 / 659112454 / 0230339		
Poziyon/ Position	Ön / Front		
Somun / Wheel Nut	SOM-0322		
Model			

MN-3197

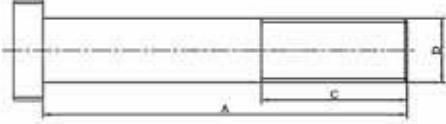

TEKNİK ÖZELLİKLER / TECHNICAL SPECIFICATION

A(mm)	C (mm)	D (mm)	Kalite / Quality
140	50	M18x2	10.9
Org. No		0250702300 / 0257704500 / 81454220027 / 3874020570	
Pozisyon/ Position		Ön / Front	
Somun / Wheel Nut		SOM-0322	
Model			

NEP-1102

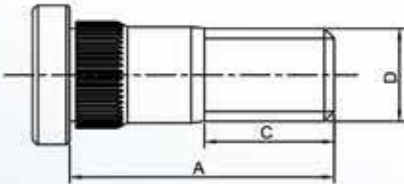

TEKNİK ÖZELLİKLER / TECHNICAL SPECIFICATION

A(mm)	C (mm)	D (mm)	Kalite / Quality
66	37	M22x1.5	10.9
Org. No			
Pozisyon/ Position		Ön / Front	
Somun / Wheel Nut		SOM-0140	
Model		NEOPLAN	

NEP-1103

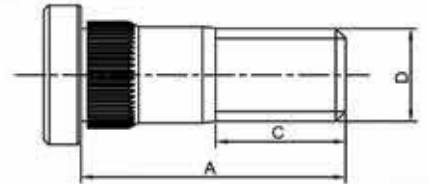

TEKNİK ÖZELLİKLER / TECHNICAL SPECIFICATION

A(mm)	C (mm)	D (mm)	Kalite / Quality
83	49	M22x1.5	10.9
Org. No		70156200	
Pozisyon/ Position		Arka / Rear	
Somun / Wheel Nut		SOM-0140	
Model		NEOPLAN	

CHR-5125

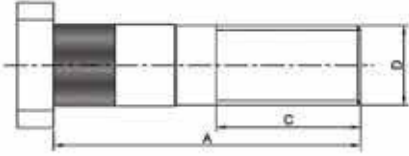

TEKNİK ÖZELLİKLER / TECHNICAL SPECIFICATION			
A(mm)	C (mm)	D (mm)	Kalite / Quality
85	40	M22x1.5	10.9
Org. No		3416 T	
Poziyon/ Position		Ön / Front	
Somun / Wheel Nut		SOM-0241	
Model		AS 900	

CHR-5126

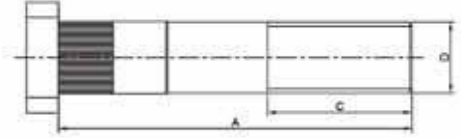

TEKNİK ÖZELLİKLER / TECHNICAL SPECIFICATION			
A(mm)	C (mm)	D (mm)	Kalite / Quality
110	45	M22x1.5	10.9
Org. No		3417 T	
Poziyon/ Position		Arka / Rear	
Somun / Wheel Nut		SOM-0241	
Model		AS 900	

CHR-5128

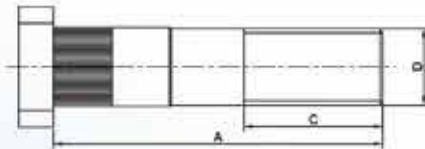

TEKNİK ÖZELLİKLER / TECHNICAL SPECIFICATION			
A(mm)	C (mm)	D (mm)	Kalite / Quality
95	40	M22x1.5	10.9
Org. No		25033 -T	
Poziyon/ Position		Ön / Front	
Somun / Wheel Nut		SOM-0240	
Model		AS 950	

CHR-5129

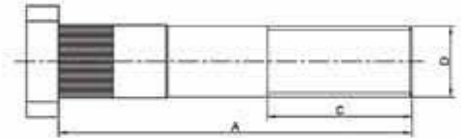

TEKNİK ÖZELLİKLER / TECHNICAL SPECIFICATION			
A(mm)	C (mm)	D (mm)	Kalite / Quality
115	55	M22x1.5	10.9
Org. No		15034 - T	
Poziyon/ Position		Arka / Rear	
Somun / Wheel Nut		SOM-0242	
Model		AS 950	

CHR-5131

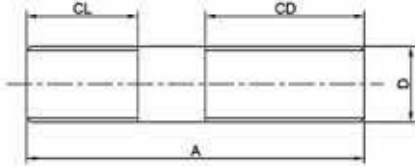

TEKNİK ÖZELLİKLER / TECHNICAL SPECIFICATION			
A(mm)	C (mm)	D (mm)	Kalite / Quality
85	40	W3/4"x10	10.9
Org. No			
Poziyon/ Position	Arka / Rear		
Somun / Wheel Nut	SOM-0430		
Model	DODGE SAPLAMASI		

CHR-5132

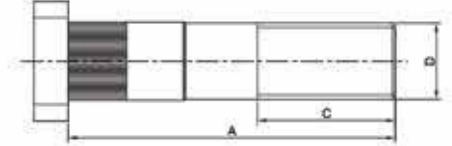

TEKNİK ÖZELLİKLER / TECHNICAL SPECIFICATION			
A(mm)	C (mm)	D (mm)	Kalite / Quality
95	40	22x1.5	10.9
Org. No	15033 T		
Poziyon/ Position	Ön / Front		
Somun / Wheel Nut	SOM-0141		
Model	AS 26 200 - AS 26 235 - AS 32 260		

CHR-5133



TEKNİK ÖZELLİKLER / TECHNICAL SPECIFICATION			
A(mm)	C (mm)	D (mm)	Kalite / Quality
123	45	M22x1.5	10.9
Org. No	15034 T		
Poziyon/ Position	Arka / Rear		
Somun / Wheel Nut	SOM-0141		
Model	AS 26 200 - AS 26 235 - AS 32 260		

CHR-5134

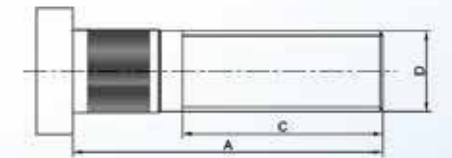

TEKNİK ÖZELLİKLER / TECHNICAL SPECIFICATION			
A(mm)	C (mm)	D (mm)	Kalite / Quality
85	45	M22x1.5	10.9
Org. No	21022167		
Poziyon/ Position	Arka / Rear		
Somun / Wheel Nut	SOM-0141		
Model	AS 26 200 - AS 26 235 - AS 32 260		

FT-4125-L-R

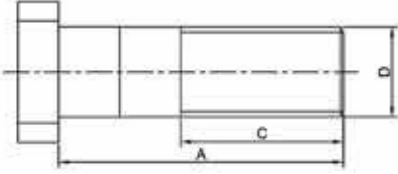

TEKNİK ÖZELLİKLER / TECHNICAL SPECIFICATION

A(mm)	C (mm)	D (mm)	Kalite / Quality
70	40	W7/8"X14	10.9
Org. No			
Poziyon/ Position		Arka / Rear	
Somun / Wheel Nut		SOM-0270-L-R	
Model		105.8	

FT-4126-L-R

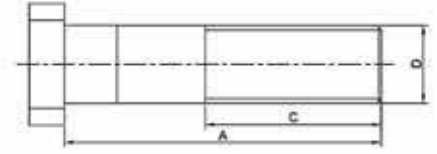

TEKNİK ÖZELLİKLER / TECHNICAL SPECIFICATION

A(mm)	C (mm)	D (mm)	Kalite / Quality
90	50	W7/8"X14	10.9
Org. No			
Poziyon/ Position		Arka / Rear	
Somun / Wheel Nut		SOM-0270-L-R	
Model		105.B	

FT-4127-L-R

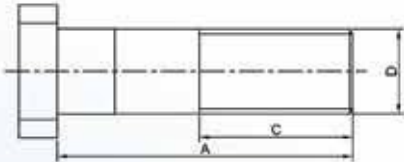

TEKNİK ÖZELLİKLER / TECHNICAL SPECIFICATION

A(mm)	C (mm)	D (mm)	Kalite / Quality
77	40	W7/8"X14	10.9
Org. No		K5C 2150 / K5C 1051	
Poziyon/ Position		Arka / Rear	
Somun / Wheel Nut		SOM-0270-L-R	
Model		162.25	

FT-4128-L-R



TEKNİK ÖZELLİKLER / TECHNICAL SPECIFICATION

A(mm)	C (mm)	D (mm)	Kalite / Quality
110	55	W7/8"X14	10.9
Org. No		K5C 2150 / K5C2151	
Poziyon/ Position		Arka / Rear	
Somun / Wheel Nut		SOM-0271-L-R	
Model		162.25	

FT-4129-L-R

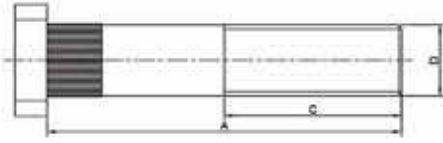

TEKNİK ÖZELLİKLER / TECHNICAL SPECIFICATION

A(mm)	C (mm)	D (mm)	Kalite / Quality
110	55	W7/8"X14	10.9
Org. No			
Pozisyon/ Position		Arka / Rear	
Somun / Wheel Nut		SOM-0271-L-R	
Model			

FT-4134

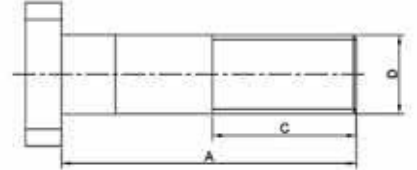

TEKNİK ÖZELLİKLER / TECHNICAL SPECIFICATION

A(mm)	C (mm)	D (mm)	Kalite / Quality
102	40	M22x1.5	10.9
Org. No		7K 60 192	
Pozisyon/ Position		Ön / Front	
Somun / Wheel Nut		SOM-0143	
Model		200.26 220.26 PROFESYONEL	

FT-4135



TEKNİK ÖZELLİKLER / TECHNICAL SPECIFICATION

A(mm)	C (mm)	D (mm)	Kalite / Quality
117	45	M22x1.5	10.9
Org. No		7K 60177	
Pozisyon/ Position		Arka / Rear	
Somun / Wheel Nut		SOM-0143	
Model		200.26 - 220.26 PROFESSIONAL	

FT-4136

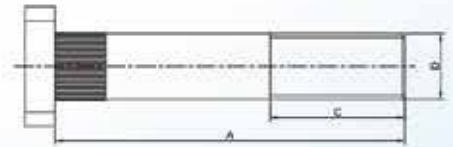

TEKNİK ÖZELLİKLER / TECHNICAL SPECIFICATION

A(mm)	C (mm)	D (mm)	Kalite / Quality
117	45	M22x1.5	10.9
Org. No			
Pozisyon/ Position		Arka / Rear	
Somun / Wheel Nut		SOM-0143	
Model		200.26 - 220.26 - PROFESSIONAL	

FT-4137



TEKNİK ÖZELLİKLER / TECHNICAL SPECIFICATION

A(mm)	C (mm)	D (mm)	Kalite / Quality
117	45	M24x1.5	10.9
Org. No			
Poziyon/ Position		Arka / Rear	
Somun / Wheel Nut		SOM-0160	
Model		200.26 - 220.26 PROFESSIONAL	

FT-4138

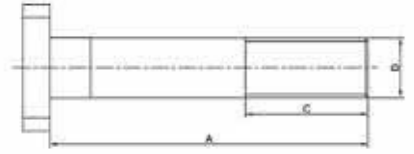

TEKNİK ÖZELLİKLER / TECHNICAL SPECIFICATION

A(mm)	C (mm)	D (mm)	Kalite / Quality
132	45	M22x1.5	10.9
Org. No			
Poziyon/ Position		Arka / Rear	
Somun / Wheel Nut		SOM-0143	
Model		220.26 - 270 - PROFESSIONAL	

VL-9125

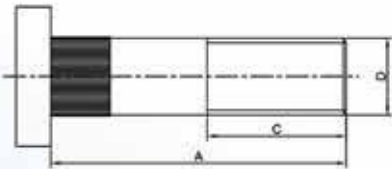

TEKNİK ÖZELLİKLER / TECHNICAL SPECIFICATION

A(mm)	C (mm)	D (mm)	Kalite / Quality
85	40	W7/8"x14	10.9
Org. No		1573081	
Poziyon/ Position		Ön / Front	
Somun / Wheel Nut		SOM-0180 SOM-0179	
Model		VOLVO FH	

VL-9126

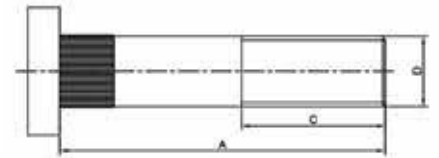

TEKNİK ÖZELLİKLER / TECHNICAL SPECIFICATION

A(mm)	C (mm)	D (mm)	Kalite / Quality
102	45	W7/8"x14	10.9
Org. No		1573082	
Poziyon/ Position		Arka / Rear	
Somun / Wheel Nut		SOM-0180 SOM-0179	
Model		VOLVO FH	

VL-9127

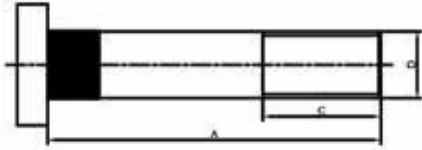

TEKNİK ÖZELLİKLER / TECHNICAL SPECIFICATION			
A(mm)	C (mm)	D (mm)	Kalite / Quality
110	39	W7/8"x14	10.9
Org. No		157308311589010	
Poziyon/ Position		Arka / Rear	
Somun / Wheel Nut		SOM-0180-SOM-0179	
Model			

VL-9128

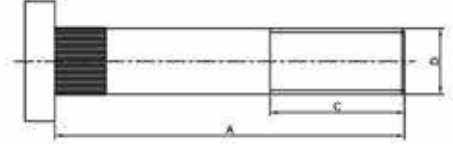

TEKNİK ÖZELLİKLER / TECHNICAL SPECIFICATION			
A(mm)	C (mm)	D (mm)	Kalite / Quality
117	45	W7/8"x14	10.9
Org. No		1589008-8	
Poziyon/ Position		Arka / Rear	
Somun / Wheel Nut		SOM-0180 SOM-0179	
Model			

VL-9129

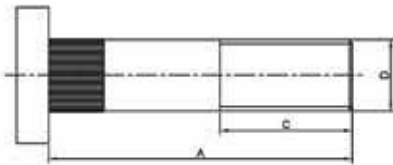

TEKNİK ÖZELLİKLER / TECHNICAL SPECIFICATION			
A(mm)	C (mm)	D (mm)	Kalite / Quality
94	41	W7/8"x14	10.9
Org. No		3963997	
Poziyon/ Position		Arka / Rear	
Somun / Wheel Nut		SOM-0180 SOM-0179	
Model			

VL-9130



TEKNİK ÖZELLİKLER / TECHNICAL SPECIFICATION			
A(mm)	C (mm)	D (mm)	Kalite / Quality
77	39	W7/8"x14	10.9
Org. No		31125931 3118981	
Poziyon/ Position		Arka / Rear	
Somun / Wheel Nut		SOM-0180 SOM-0179	
Model		F10 F10/260;F10 / 280 / 300 / 320	

VL-9137

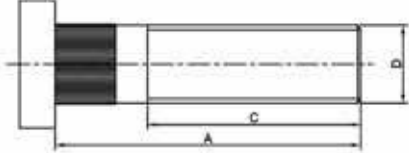

TEKNİK ÖZELLİKLER / TECHNICAL SPECIFICATION

A(mm)	C (mm)	D (mm)	Kalite / Quality
88	60	M22x1.5	10.9
Org. No		20515515	
Poziyon/ Position		Ön / Front	
Somun / Wheel Nut		SOM-0141	
Model		FM	

VL-9138



TEKNİK ÖZELLİKLER / TECHNICAL SPECIFICATION

A(mm)	C (mm)	D (mm)	Kalite / Quality
105	77	M22x1.5	10.9
Org. No		20515519	
Poziyon/ Position		Arka / Rear	
Somun / Wheel Nut		SOM-0141	
Model		FM	

VL-9139



TEKNİK ÖZELLİKLER / TECHNICAL SPECIFICATION

A(mm)	C (mm)	D (mm)	Kalite / Quality
114	86	M22x1.5	10.9
Org. No		20524942	
Poziyon/ Position		Arka / Rear	
Somun / Wheel Nut		SOM-0141	
Model		FM	

VL-9160

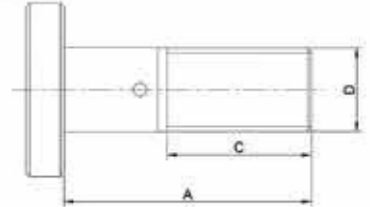

TEKNİK ÖZELLİKLER / TECHNICAL SPECIFICATION

A(mm)	C (mm)	D (mm)	Kalite / Quality
65	38	M20x2	10.9
Org. No		659112500 / 3174020170 / 34640115270 / 6244010270 / 0293493/ 362164 / 0250700	
Poziyon/ Position		Ön / Front	
Somun / Wheel Nut		SOM-0333	
Model			

VL-9161



TEKNİK ÖZELLİKLER / TECHNICAL SPECIFICATION

A(mm)	C (mm)	D (mm)	Kalite / Quality
110	50	M20x2	10.9
Org. No	659 112 501		
Poziyon/ Position	Arka / Rear		
Somun / Wheel Nut	SOM-0333		
Model			

VL-9163



TEKNİK ÖZELLİKLER / TECHNICAL SPECIFICATION

A(mm)	C (mm)	D (mm)	Kalite / Quality
145	50	M20x2	10.9
Org. No	659 112 614		
Poziyon/ Position	Arka / Rear		
Somun / Wheel Nut	SOM-0333		
Model			

VL-9164

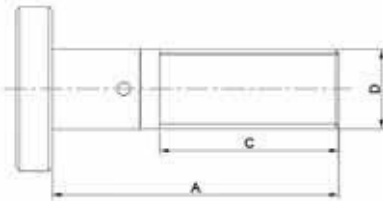

TEKNİK ÖZELLİKLER / TECHNICAL SPECIFICATION

A(mm)	C (mm)	D (mm)	Kalite / Quality
80	50	M20x2	10.9
Org. No	659112509 / 3954010070 / 814542246		
Poziyon/ Position	Arka / Rear		
Somun / Wheel Nut	SOM-0333		
Model			

VL-9165

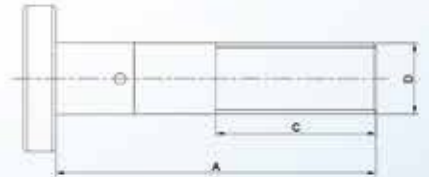

TEKNİK ÖZELLİKLER / TECHNICAL SPECIFICATION

A(mm)	C (mm)	D (mm)	Kalite / Quality
100	50	M20x2	10.9
Org. No	659112611 / 272740 / 0250708600 / 0288799		
Poziyon/ Position	Arka / Rear		
Somun / Wheel Nut	SOM-0333		
Model			

VL-9166

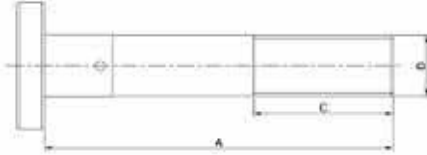

TEKNİK ÖZELLİKLER / TECHNICAL SPECIFICATION			
A(mm)	C (mm)	D (mm)	Kalite / Quality
125	50	M20x2	10.9
Org. No		659 112 503	
Poziyon/ Position		Arka / Rear	
Somun / Wheel Nut		SOM-0333	
Model			

VL-9167



TEKNİK ÖZELLİKLER / TECHNICAL SPECIFICATION			
A(mm)	C (mm)	D (mm)	Kalite / Quality
115	52	M20x2	10.9
Org. No		0250703700 / 0250703200 / 814542260 S1 / 6204010170 / 0289535 / 1608293 / 659112612	
Poziyon/ Position		Arka / Rear	
Somun / Wheel Nut		SOM-0333	
Model			

VL-9168

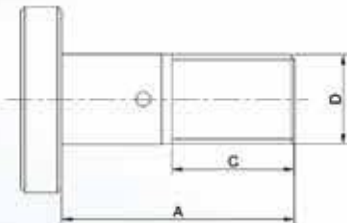

TEKNİK ÖZELLİKLER / TECHNICAL SPECIFICATION			
A(mm)	C (mm)	D (mm)	Kalite / Quality
57	30	M20x2	10.9
Org. No		0250708900 / 6204010070 / 0338883 / 1588406 / 659112616	
Poziyon/ Position		Ön / Front	
Somun / Wheel Nut		SOM-0333	
Model			

VL-9169



TEKNİK ÖZELLİKLER / TECHNICAL SPECIFICATION			
A(mm)	C (mm)	D (mm)	Kalite / Quality
130	52	M20x2	10.9
Org. No		659112613 / 0250708700 / 0250704300	
Poziyon/ Position		Arka / Rear	
Somun / Wheel Nut		SOM-0333	
Model			

IVC-7125

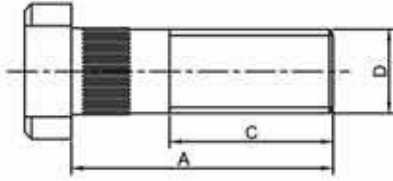

TEKNİK ÖZELLİKLER / TECHNICAL SPECIFICATION

A(mm)	C (mm)	D (mm)	Kalite / Quality
56	35	M18x1.5	10.9
Org. No		7168346	
Poziyon/ Position		Ön / Front	
Somun / Wheel Nut		SOM-0220	
Model		50 NC	

IVC-7126

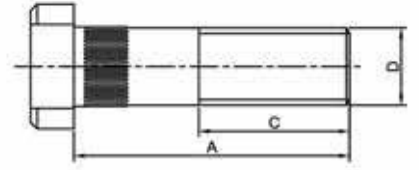

TEKNİK ÖZELLİKLER / TECHNICAL SPECIFICATION

A(mm)	C (mm)	D (mm)	Kalite / Quality
64	35	M18x1.5	10.9
Org. No		7168257 / 042117463	
Poziyon/ Position		Arka / Rear	
Somun / Wheel Nut		SOM-0220	
Model		50 NC	

IVC-7127

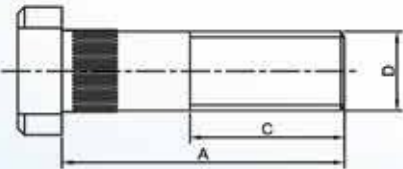

TEKNİK ÖZELLİKLER / TECHNICAL SPECIFICATION

A(mm)	C (mm)	D (mm)	Kalite / Quality
64	35	M18x1.5	10.9
Org. No			
Poziyon/ Position		Arka / Rear	
Somun / Wheel Nut		SOM-0220	
Model		50 NC	

IVC-7128

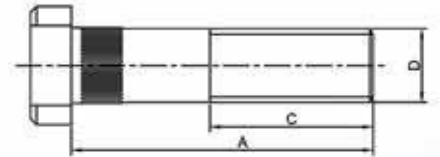

TEKNİK ÖZELLİKLER / TECHNICAL SPECIFICATION

A(mm)	C (mm)	D (mm)	Kalite / Quality
74	40	M18x1.5	10.9
Org. No		7168333	
Poziyon/ Position		Arka / Rear	
Somun / Wheel Nut		SOM-0220	
Model		50 NC	

IVC-7139

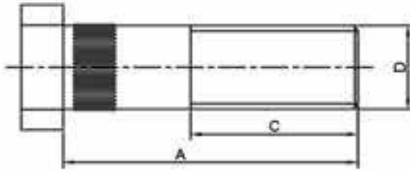

TEKNİK ÖZELLİKLER / TECHNICAL SPECIFICATION

A(mm)	C (mm)	D (mm)	Kalite / Quality
70.5	40	M20x1.5	10.9
Org. No	42117433		
Pozisyon/ Position	Ön / Front		
Somun / Wheel Nut	SOM-0131		
Model	EUROBUS		

IVC-7140

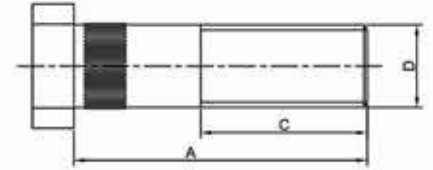

TEKNİK ÖZELLİKLER / TECHNICAL SPECIFICATION

A(mm)	C (mm)	D (mm)	Kalite / Quality
75.5	40	M20x1.5	10.9
Org. No	4206 4829		
Pozisyon/ Position	Arka / Rear		
Somun / Wheel Nut	SOM-0131		
Model	EUROBUS		

IVC-7151



TEKNİK ÖZELLİKLER / TECHNICAL SPECIFICATION

A(mm)	C (mm)	D (mm)	Kalite / Quality
120	40	M22x1.5	10.9
Org. No	4211 7457		
Pozisyon/ Position	Arka / Rear		
Somun / Wheel Nut	SOM-0141		
Model	EUROTECH		

IVC-7152



TEKNİK ÖZELLİKLER / TECHNICAL SPECIFICATION

A(mm)	C (mm)	D (mm)	Kalite / Quality
110	40	M22x1.5	10.9
Org. No	42117455 / 02477764		
Pozisyon/ Position	Arka / Rear		
Somun / Wheel Nut	SOM-0141		
Model	TURBOSTAR 190,36 - 190,40		

IVC-7153



TEKNİK ÖZELLİKLER / TECHNICAL SPECIFICATION

A(mm)	C (mm)	D (mm)	Kalite / Quality
115	38	M22x1.5	10.9
Org. No	4211 7456		
Poziyon/ Position	--		
Somun / Wheel Nut	SOM-0141		
Model			

IVC-7154



TEKNİK ÖZELLİKLER / TECHNICAL SPECIFICATION

A(mm)	C (mm)	D (mm)	Kalite / Quality
135	38	M22x1.5	10.9
Org. No	4211 7461		
Poziyon/ Position	--		
Somun / Wheel Nut	SOM-0141		
Model			

IVC-7155



TEKNİK ÖZELLİKLER / TECHNICAL SPECIFICATION

A(mm)	C (mm)	D (mm)	Kalite / Quality
85	40	M22x1.5	10.9
Org. No	4211 7449 / 7168580 / 02476077 / 421 01338		
Poziyon/ Position	Ön / Front		
Somun / Wheel Nut	SOM-0141		
Model	TURBOSTAR / TURBO		

IVC-7156



TEKNİK ÖZELLİKLER / TECHNICAL SPECIFICATION

A(mm)	C (mm)	D (mm)	Kalite / Quality
95	40	M22x1.5	10.9
Org. No	4211 7452 /		
Poziyon/ Position	Ön / Front		
Somun / Wheel Nut	SOM-0141		
Model	EUROTECH ; EUTOSTAR ; TRAKKER		

IVC-7157

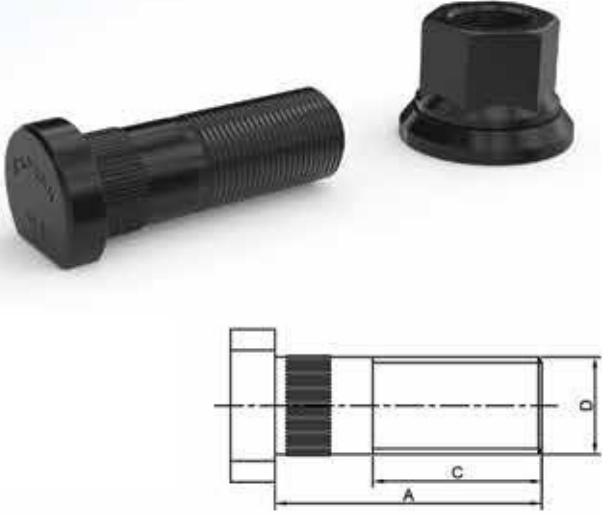

TEKNİK ÖZELLİKLER / TECHNICAL SPECIFICATION			
A(mm)	C (mm)	D (mm)	Kalite / Quality
65	38	M22x1.5	10.9
Org. No		4211 7445	
Poziyon/ Position		Ön / Front	
Somun / Wheel Nut		SOM-0140	
Model			

IVC-7159



TEKNİK ÖZELLİKLER / TECHNICAL SPECIFICATION			
A(mm)	C (mm)	D (mm)	Kalite / Quality
100	38	M22x1.5	10.9
Org. No		4211 7453 / 2476077 / 7168465	
Poziyon/ Position		--	
Somun / Wheel Nut		SOM-0141	
Model		EUROTECH ; EUTOSTAR; TRAKKER	

IVC-7158



TEKNİK ÖZELLİKLER / TECHNICAL SPECIFICATION			
A(mm)	C (mm)	D (mm)	Kalite / Quality
75	38	M22x1.5	10.9
Org. No		4211 7447	
Poziyon/ Position		--	
Somun / Wheel Nut		SOM-0140	
Model			

IVC-7160



TEKNİK ÖZELLİKLER / TECHNICAL SPECIFICATION			
A(mm)	C (mm)	D (mm)	Kalite / Quality
105	38	M22x1.5	10.9
Org. No		4211 7454	
Poziyon/ Position		--	
Somun / Wheel Nut		SOM-0141	
Model			

IVC-7161



TEKNİK ÖZELLİKLER / TECHNICAL SPECIFICATION

A(mm)	C (mm)	D (mm)	Kalite / Quality
130	40	M22x1.5	10.9
Org. No		42117459	
Poziyon/ Position		Arka / Rear	
Somun / Wheel Nut		SOM-0141	
Model			

IVC-7162

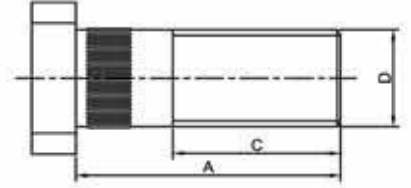

TEKNİK ÖZELLİKLER / TECHNICAL SPECIFICATION

A(mm)	C (mm)	D (mm)	Kalite / Quality
60	38	M22x1.5	10.9
Org. No		4211 7444	
Poziyon/ Position		--	
Somun / Wheel Nut		SOM-0140	
Model			

IVC-7163

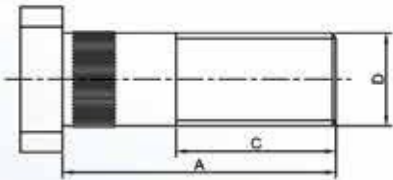

TEKNİK ÖZELLİKLER / TECHNICAL SPECIFICATION

A(mm)	C (mm)	D (mm)	Kalite / Quality
70	38	M22x1.5	10.9
Org. No		4211 7446	
Poziyon/ Position		--	
Somun / Wheel Nut		SOM-0140	
Model			

IVC-7164

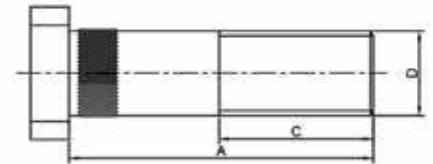

TEKNİK ÖZELLİKLER / TECHNICAL SPECIFICATION

A(mm)	C (mm)	D (mm)	Kalite / Quality
79	40	M22x1.5	10.9
Org. No		4211 7448	
Poziyon/ Position		--	
Somun / Wheel Nut		SOM-0141	
Model			

IVC-7165

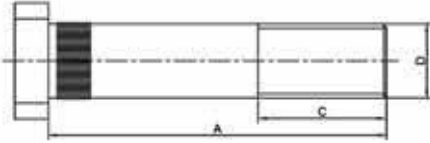

TEKNİK ÖZELLİKLER / TECHNICAL SPECIFICATION			
A(mm)	C (mm)	D (mm)	Kalite / Quality
65	35	M18x1.5	10.9
Org. No		7168257 / 42117463 / 40390478	
Poziyon/ Position			
Somun / Wheel Nut		SOM-0120	
Model		EURO CARGO	

IVC-7166

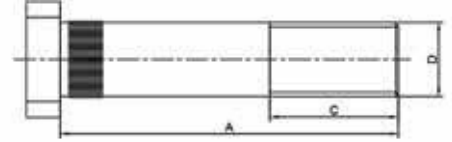

TEKNİK ÖZELLİKLER / TECHNICAL SPECIFICATION			
A(mm)	C (mm)	D (mm)	Kalite / Quality
60	38	M22x1.5	10.9
Org. No		4211 7444	
Poziyon/ Position		Ön / Front	
Somun / Wheel Nut		SOM-0140	
Model			

IVC-7167

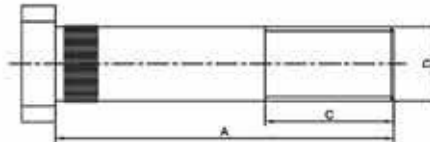

TEKNİK ÖZELLİKLER / TECHNICAL SPECIFICATION			
A(mm)	C (mm)	D (mm)	Kalite / Quality
130	40	M22x1.5	10.9
Org. No		4211 7459	
Poziyon/ Position		Arka / Rear	
Somun / Wheel Nut		SOM-0141	
Model			

SCN-8125

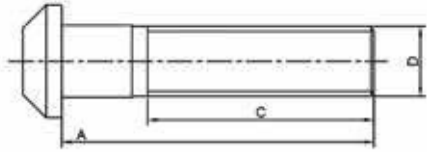

SCN-8126

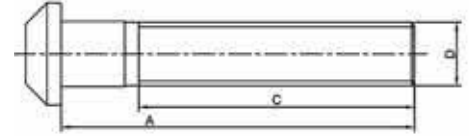

TEKNİK ÖZELLİKLER / TECHNICAL SPECIFICATION

A(mm)	C (mm)	D (mm)	Kalite / Quality
80	58	W7/8"x11	10.9
Org. No		337559 / 1368692	
Poziyon/ Position		Ön / Front	
Somun / Wheel Nut		SOM-0170	
Model			

TEKNİK ÖZELLİKLER / TECHNICAL SPECIFICATION

A(mm)	C (mm)	D (mm)	Kalite / Quality
100	78	W7/8"x11	10.9
Org. No		0272853	
Poziyon/ Position		Arka / Rear	
Somun / Wheel Nut		SOM-0170	
Model			

SCN-8127

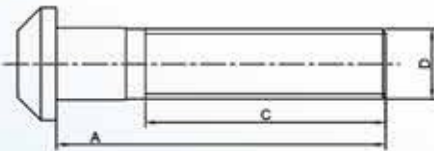

SCN-8128

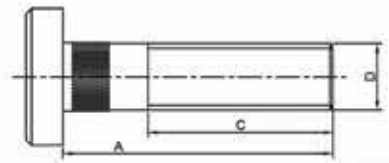

TEKNİK ÖZELLİKLER / TECHNICAL SPECIFICATION

A(mm)	C (mm)	D (mm)	Kalite / Quality
85	62	W7/8"x11	10.9
Org. No		1368693	
Poziyon/ Position		Arka / Rear	
Somun / Wheel Nut		SOM-0170	
Model			

TEKNİK ÖZELLİKLER / TECHNICAL SPECIFICATION

A(mm)	C (mm)	D (mm)	Kalite / Quality
73	50	W7/8"x11	10.9
Org. No		1868665	
Poziyon/ Position		Ön / Front	
Somun / Wheel Nut		Som-0170	
Model			

SCN-8129

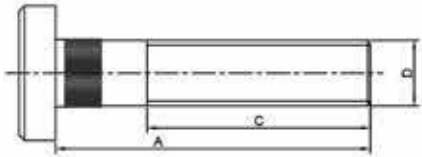

TEKNİK ÖZELLİKLER / TECHNICAL SPECIFICATION			
A(mm)	C (mm)	D (mm)	Kalite / Quality
86	61	W7/8"x11	10.9
Org. No		1528712	
Poziyon/ Position		Arka / Rear	
Somun / Wheel Nut		SOM-0170	
Model			

SCN-8130

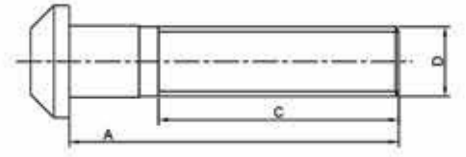

TEKNİK ÖZELLİKLER / TECHNICAL SPECIFICATION			
A(mm)	C (mm)	D (mm)	Kalite / Quality
70	49	W7/8"x11	10.9
Org. No		290062 / 397266 / 1368690	
Poziyon/ Position		Ön / Front	
Somun / Wheel Nut		Som-0170	
Model		Disk / For Disc	

SCN-8131

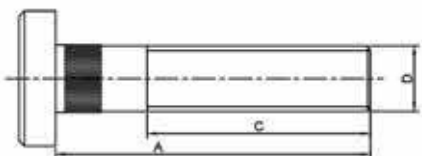

TEKNİK ÖZELLİKLER / TECHNICAL SPECIFICATION			
A(mm)	C (mm)	D (mm)	Kalite / Quality
96	67	W7/8"x11	10.9
Org. No		1868668	
Poziyon/ Position		Arka / Rear	
Somun / Wheel Nut		SOM-0170	
Model			

SCN-8132



TEKNİK ÖZELLİKLER / TECHNICAL SPECIFICATION			
A(mm)	C (mm)	D (mm)	Kalite / Quality
102	70	W7/8"x11	10.9
Org. No		1528655	
Poziyon/ Position		Arka / Rear	
Somun / Wheel Nut		Som-0170	
Model			

DRS-30148

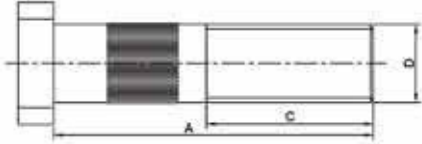

TEKNİK ÖZELLİKLER / TECHNICAL SPECIFICATION

A(mm)	C (mm)	D (mm)	Kalite / Quality
90	40	M22x1.5	10.9
Org. No			
Poziyon/ Position		--	
Somun / Wheel Nut		SOM-0141	
Model		PİLOT	

DRS-30222

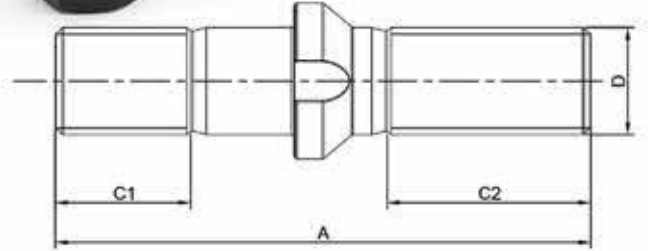

TEKNİK ÖZELLİKLER / TECHNICAL SPECIFICATION

A(mm)	C (mm)	D (mm)	Kalite / Quality
110	28-42	M22x2	10.9
Org. No			
Poziyon/ Position			
Somun / Wheel Nut		SOM-0451 / SOM-0150	
Model			

DRS-30223

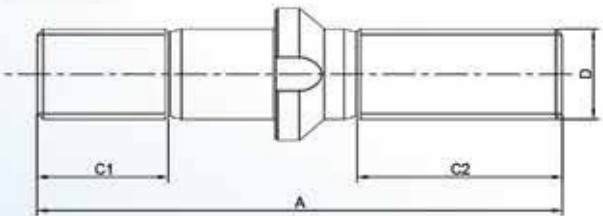

TEKNİK ÖZELLİKLER / TECHNICAL SPECIFICATION

A(mm)	C (mm)	D (mm)	Kalite / Quality
128	32-50	M22x2	10.9
Org. No		0329613170	
Poziyon/ Position			
Somun / Wheel Nut		SOM-0452 / SOM-0250	
Model			

DRS-30224

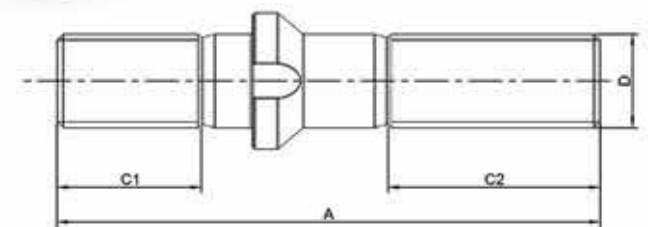

TEKNİK ÖZELLİKLER / TECHNICAL SPECIFICATION

A(mm)	C (mm)	D (mm)	Kalite / Quality
128	34-50	M22x2	10.9
Org. No			
Poziyon/ Position			
Somun / Wheel Nut		SOM-0452 / SOM-0250	
Model			

DRS-30225

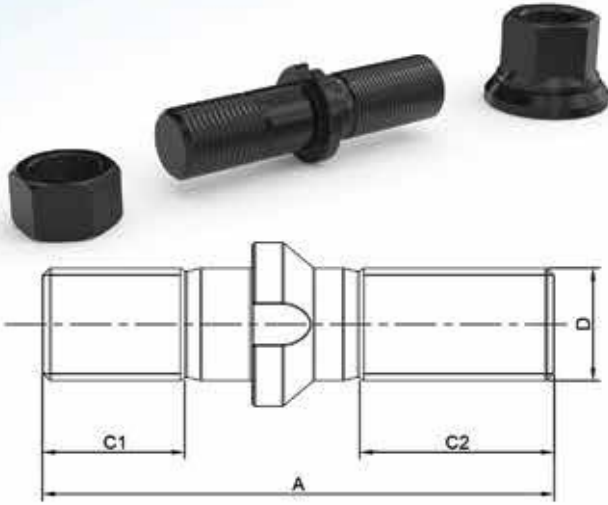

TEKNİK ÖZELLİKLER / TECHNICAL SPECIFICATION			
A(mm)	C (mm)	D (mm)	Kalite / Quality
105	28-38	M22x2 M22x1.5	10.9
Org. No		03.296.23.150	
Poziyon/ Position			
Somun / Wheel Nut		SOM-0451 / SOM-0140	
Model			

DRS-30227



TEKNİK ÖZELLİKLER / TECHNICAL SPECIFICATION			
A(mm)	C (mm)	D (mm)	Kalite / Quality
80	38.5	M22x1.5	10.9
Org. No		03.296.33.110	
Poziyon/ Position			
Somun / Wheel Nut		SOM-0140	
Model			

DRS-30226

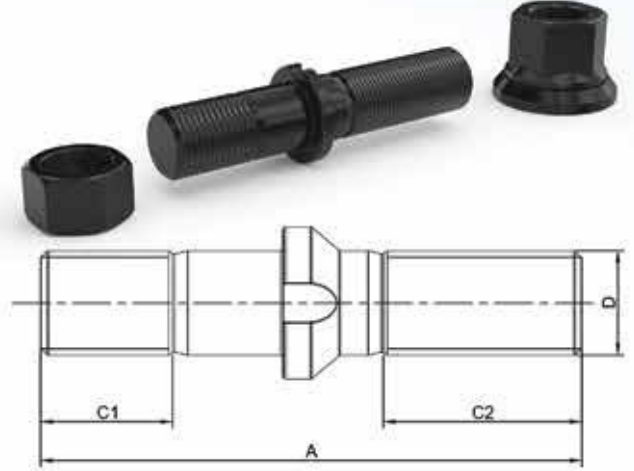

TEKNİK ÖZELLİKLER / TECHNICAL SPECIFICATION			
A(mm)	C (mm)	D (mm)	Kalite / Quality
114	28-51	M22x2 M22x1.5	10.9
Org. No		03.296.23.170 / 8241000989 09.806.13.02.0	
Poziyon/ Position			
Somun / Wheel Nut		SOM-0451 / SOM-141	
Model			

DRS-30228



TEKNİK ÖZELLİKLER / TECHNICAL SPECIFICATION			
A(mm)	C (mm)	D (mm)	Kalite / Quality
88.5	42.5	M22x1.5	10.9
Org. No		03.296.33.111	
Poziyon/ Position			
Somun / Wheel Nut		SOM-0141	
Model			

DRS-30229

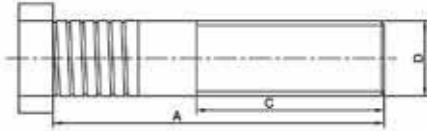

TEKNİK ÖZELLİKLER / TECHNICAL SPECIFICATION

A(mm)	C (mm)	D (mm)	Kalite / Quality
97	55	M22x1.5	10.9
Org. No	03.296.33.121		
Poziyon/ Position			
Somun / Wheel Nut	SOM-0141		
Model			

DRS-30230

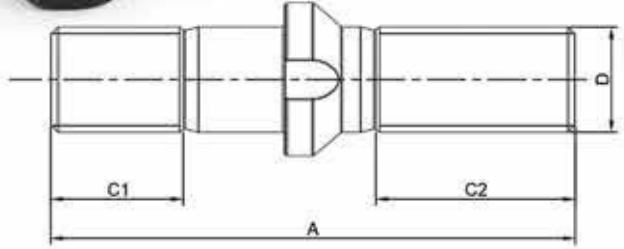

TEKNİK ÖZELLİKLER / TECHNICAL SPECIFICATION

A(mm)	C (mm)	D (mm)	Kalite / Quality
110	28-42	M22x2	10.9
Org. No	0329613090		
Poziyon/ Position			
Somun / Wheel Nut	SOM-0451 / SOM-0251		
Model			

DRS-30231

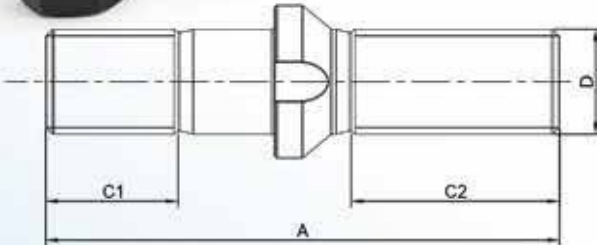

TEKNİK ÖZELLİKLER / TECHNICAL SPECIFICATION

A(mm)	C (mm)	D (mm)	Kalite / Quality
108	28-44	M22x2	10.9
Org. No	098061302		
Poziyon/ Position			
Somun / Wheel Nut	SOM-0451 / SOM-0251		
Model			

DRS-30232

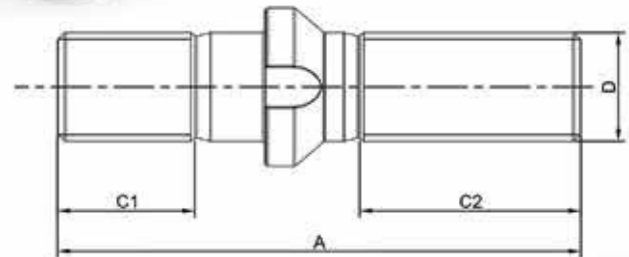

TEKNİK ÖZELLİKLER / TECHNICAL SPECIFICATION

A(mm)	C (mm)	D (mm)	Kalite / Quality
106	28-44	M20x1.5 M22x1.5	10.9
Org. No	03.296.13.070		
Poziyon/ Position			
Somun / Wheel Nut	SOM-036 / SOM-0241		
Model			

DRS-30233

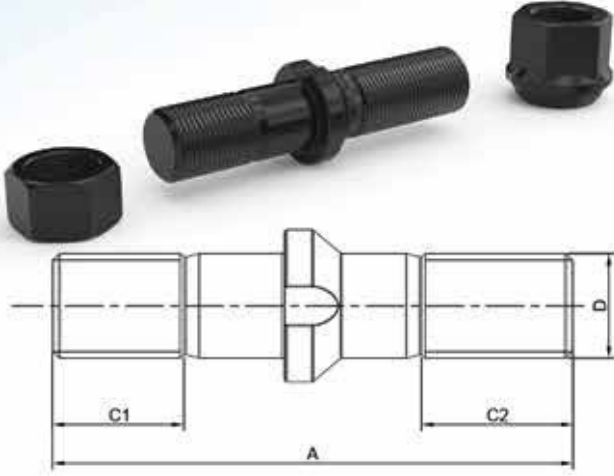

TEKNİK ÖZELLİKLER / TECHNICAL SPECIFICATION

A(mm)	C (mm)	D (mm)	Kalite / Quality
110	28-46	M22x1.5 M22x2	10.9
Org. No	03.296.13.060		
Poziyon/ Position			
Somun / Wheel Nut	SOM-0451 / SOM-0241		
Model			

DRS-30234

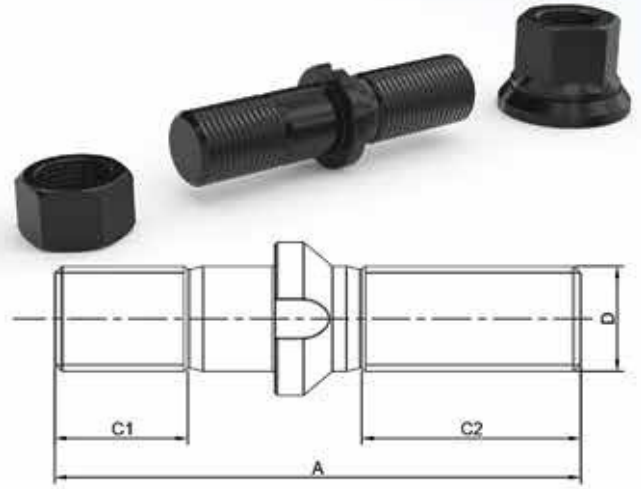

TEKNİK ÖZELLİKLER / TECHNICAL SPECIFICATION

A(mm)	C (mm)	D (mm)	Kalite / Quality
97	26-37	M22x2	10.9
Org. No	03.296.23.050		
Poziyon/ Position			
Somun / Wheel Nut	SOM-0451 / SOM-0150		
Model			

DRS-30235

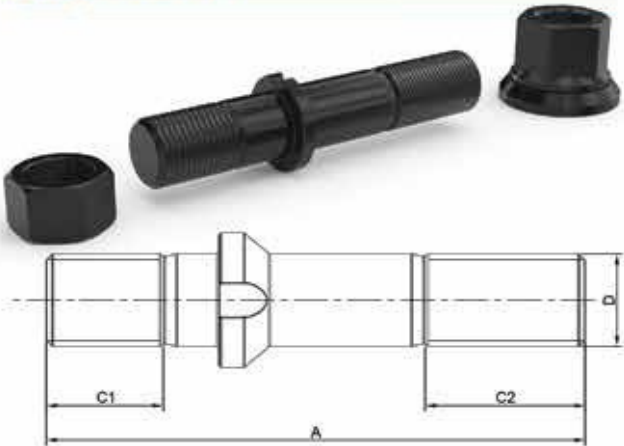

TEKNİK ÖZELLİKLER / TECHNICAL SPECIFICATION

A(mm)	C (mm)	D (mm)	Kalite / Quality
128	28-38	M22x2 M22x1.5	10.9
Org. No			
Poziyon/ Position			
Somun / Wheel Nut	SOM-0451 / SOM-0141		
Model			

DRS-30236

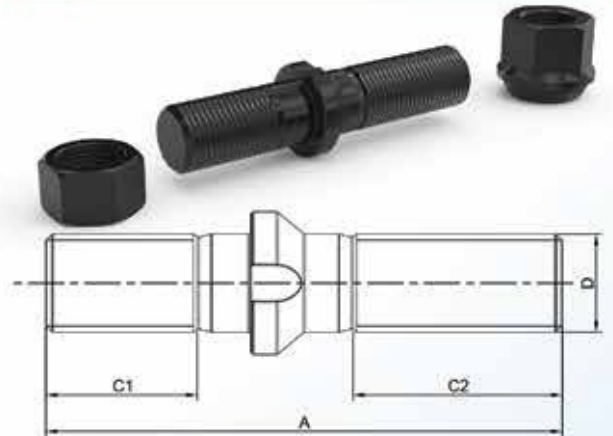

TEKNİK ÖZELLİKLER / TECHNICAL SPECIFICATION

A(mm)	C (mm)	D (mm)	Kalite / Quality
116	34-47	M22x2	10.9
Org. No	03.296.13.110		
Poziyon/ Position			
Somun / Wheel Nut	SOM-0451 / SOM-0251		
Model			

DF-10110

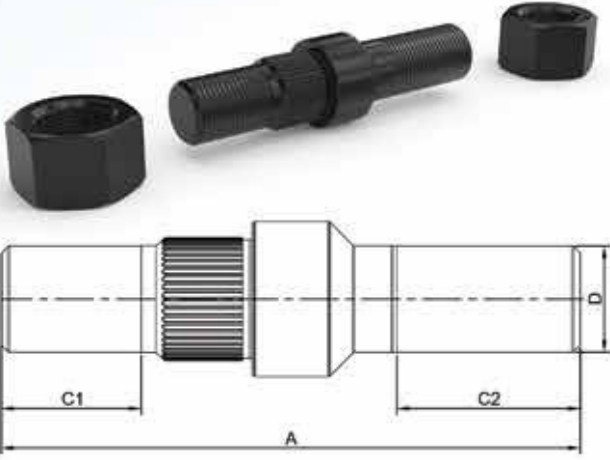

TEKNİK ÖZELLİKLER / TECHNICAL SPECIFICATION			
A(mm)	C (mm)	D (mm)	Kalite / Quality
120	28 - 38	M22x2	10.9
Org. No		259931	
Pozisyon/ Position		Arka / Rear	
Somun / Wheel Nut		SOM-0452 SOM-0455	
Model			

DF-10125

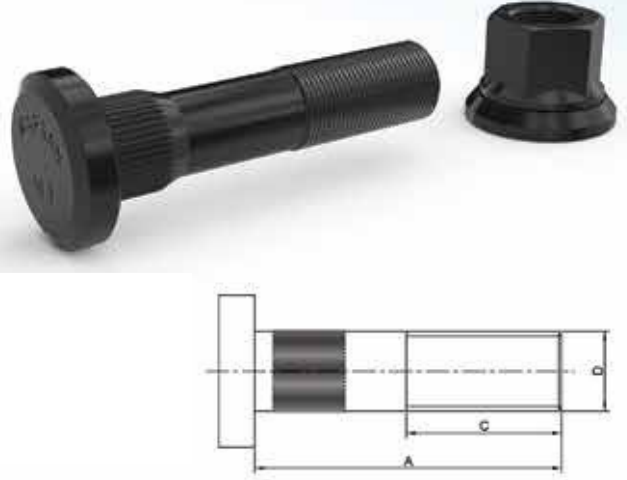

TEKNİK ÖZELLİKLER / TECHNICAL SPECIFICATION			
A(mm)	C (mm)	D (mm)	Kalite / Quality
85	46	M22x1.5	10.9
Org. No		620646 / 1309191 / 0099730	
Pozisyon/ Position		Ön / Front	
Somun / Wheel Nut		SOM-0141	
Model			

DF-10126

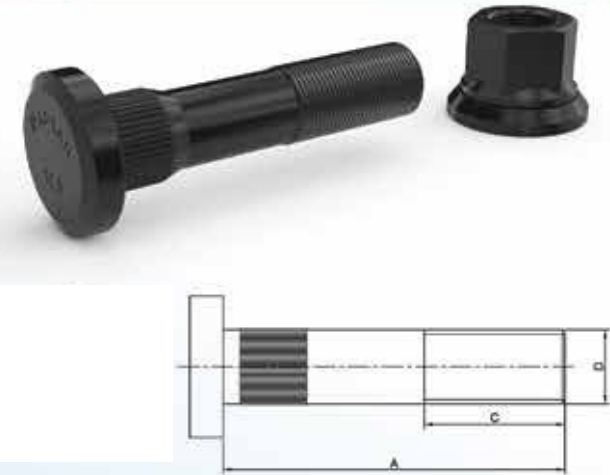

TEKNİK ÖZELLİKLER / TECHNICAL SPECIFICATION			
A(mm)	C (mm)	D (mm)	Kalite / Quality
104	45	M22x1.5	10.9
Org. No		620649 / 1308038	
Pozisyon/ Position		Arka / Rear	
Somun / Wheel Nut		SOM-0141	
Model			

DF-10128



TEKNİK ÖZELLİKLER / TECHNICAL SPECIFICATION			
A(mm)	C (mm)	D (mm)	Kalite / Quality
85	46	M22x1.5	10.9
Org. No		1309101	
Pozisyon/ Position		Arka / Rear	
Somun / Wheel Nut		SOM-0140	
Model			

DF-10129

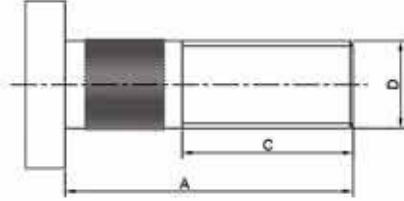

TEKNİK ÖZELLİKLER / TECHNICAL SPECIFICATION

A(mm)	C (mm)	D (mm)	Kalite / Quality
72.5	51	M22x1.5	10.9
Org. No		1337020	
Poziyon/ Position		Ön / Front	
Somun / Wheel Nut		SOM-0140	
Model			

DF-10130

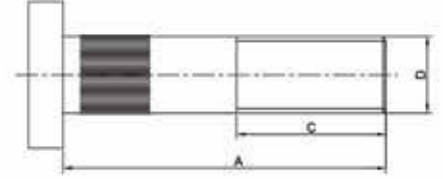

TEKNİK ÖZELLİKLER / TECHNICAL SPECIFICATION

A(mm)	C (mm)	D (mm)	Kalite / Quality
93	46	M22x1.5	10.9
Org. No		99731 / 1309190 / 890763	
Poziyon/ Position			
Somun / Wheel Nut		SOM-0141	
Model			

FD-304

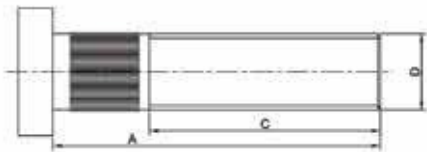

TEKNİK ÖZELLİKLER / TECHNICAL SPECIFICATION

A(mm)	C (mm)	D (mm)	Kalite / Quality
95	67	M22x1.5	10.9
Org. No			
Poziyon/ Position		--	
Somun / Wheel Nut		SOM-0141	
Model		FAS ÖZEL	

HDR-0615

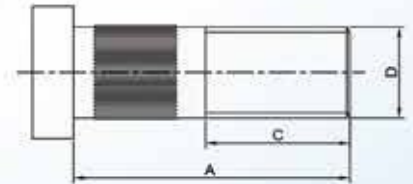

TEKNİK ÖZELLİKLER / TECHNICAL SPECIFICATION

A(mm)	C (mm)	D (mm)	Kalite / Quality
67	35	W3/4"x16	10.9
Org. No			
Poziyon/ Position			
Somun / Wheel Nut		SOM-0211	
Model		HİDROMEK JCB	

FRD-6125

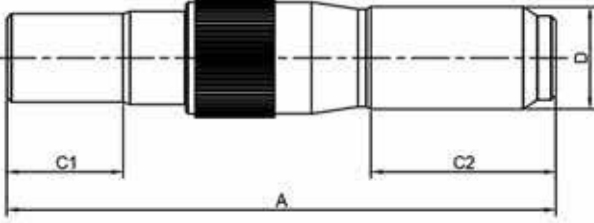

TEKNİK ÖZELLİKLER / TECHNICAL SPECIFICATION

A(mm)	C (mm)	D (mm)	Kalite / Quality
118	25 - 45	W3/4"16 - 22x1.5	10.9
Org. No	81 DB - 118 CA		
Pozisyon/ Position	--		
Somun / Wheel Nut	SOM-0310 / SOM-0141		
Model	2517 - 2520 CARGO		

FRD-6126

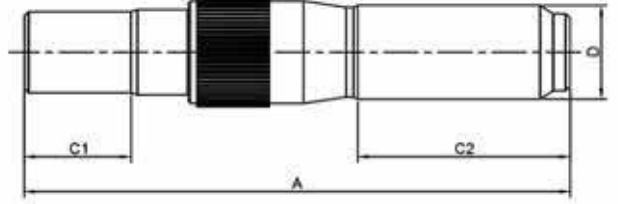

TEKNİK ÖZELLİKLER / TECHNICAL SPECIFICATION

A(mm)	C (mm)	D (mm)	Kalite / Quality
128	25-45	W3/4"16-M22x1.5	10.9
Org. No	92 CT - 111 8AA		
Pozisyon/ Position	--		
Somun / Wheel Nut	SOM-0310 / SOM-0141		
Model	2621-2626 CARGO INTERCOLER		

FRD-6127

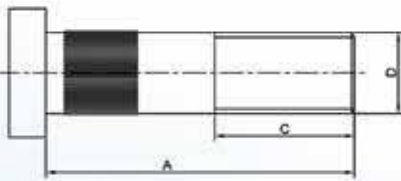

TEKNİK ÖZELLİKLER / TECHNICAL SPECIFICATION

A(mm)	C (mm)	D (mm)	Kalite / Quality
84	38	M22x1.5	10.9
Org. No			
Pozisyon/ Position	Öm / Front		
Somun / Wheel Nut	SOM-0140		
Model	2517-2520-3220 CARGO INTERCOLER		

FRD-6128

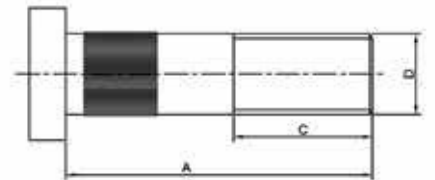

TEKNİK ÖZELLİKLER / TECHNICAL SPECIFICATION

A(mm)	C (mm)	D (mm)	Kalite / Quality
105	48	M22x1.5	10.9
Org. No			
Pozisyon/ Position	Arka / Rear		
Somun / Wheel Nut	SOM-0141		
Model	2621 - 2626 3227		

FRD-6129

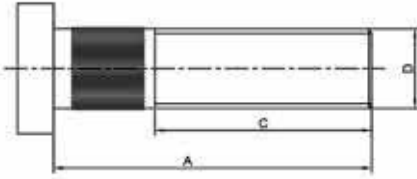

TEKNİK ÖZELLİKLER / TECHNICAL SPECIFICATION			
A(mm)	C (mm)	D (mm)	Kalite / Quality
88	60	M22x1.5	10.9
Org. No		20515515	
Pozisyon/ Position		Ön / Front	
Somun / Wheel Nut		SOM-0141	
Model		3430 CARGO	

FRD-6130

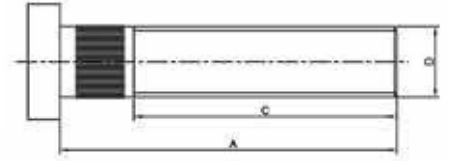

TEKNİK ÖZELLİKLER / TECHNICAL SPECIFICATION			
A(mm)	C (mm)	D (mm)	Kalite / Quality
105	82	M22x1.5	10.9
Org. No		205 155 19	
Pozisyon/ Position		Arka / Rear	
Somun / Wheel Nut		SOM-0141	
Model		3430 CARGO	

FRD-6131

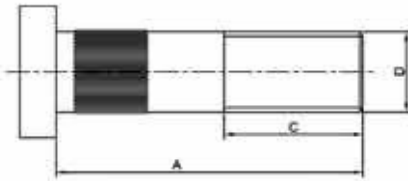

TEKNİK ÖZELLİKLER / TECHNICAL SPECIFICATION			
A(mm)	C (mm)	D (mm)	Kalite / Quality
105	60	M24x1.5	10.9
Org. No			
Pozisyon/ Position		Arka / Rear	
Somun / Wheel Nut		SOM-0160	
Model			

RN-20125

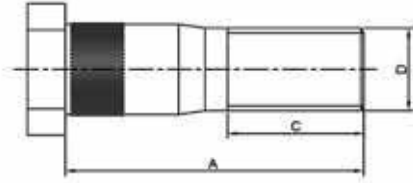

TEKNİK ÖZELLİKLER / TECHNICAL SPECIFICATION

A(mm)	C (mm)	D (mm)	Kalite / Quality
79	36	M22x1.5	10.9
Org. No	5010319141 / 0000190221		
Pozisyon/ Position	Ön / Front		
Somun / Wheel Nut	SOM-0140		
Model			

RN-20126

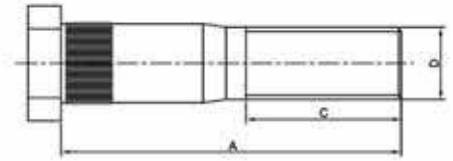

TEKNİK ÖZELLİKLER / TECHNICAL SPECIFICATION

A(mm)	C (mm)	D (mm)	Kalite / Quality
97	47	M22x1.5	10.9
Org. No	190513/0000190220		
Pozisyon/ Position	Arka / Rear		
Somun / Wheel Nut	SOM-0141		
Model			

RN-20127



TEKNİK ÖZELLİKLER / TECHNICAL SPECIFICATION

A(mm)	C (mm)	D (mm)	Kalite / Quality
114	45	M22x1.5	10.9
Org. No	5010241892		
Pozisyon/ Position	Arka / Rear		
Somun / Wheel Nut	SOM-0141		
Model	MAGNUM		

RN-20128

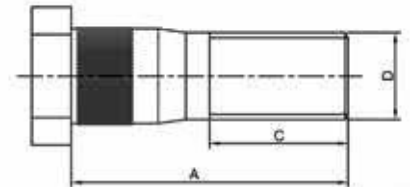

TEKNİK ÖZELLİKLER / TECHNICAL SPECIFICATION

A(mm)	C (mm)	D (mm)	Kalite / Quality
70	35	M22x1.5	10.9
Org. No	5000737601		
Pozisyon/ Position	Ön / Front		
Somun / Wheel Nut	SOM-0140		
Model			

RN-20129

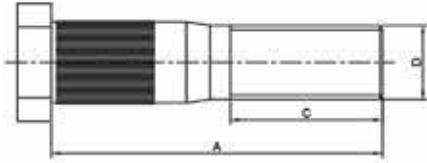

TEKNİK ÖZELLİKLER / TECHNICAL SPECIFICATION			
A(mm)	C (mm)	D (mm)	Kalite / Quality
97	45	M22x1.5	10.9
Org. No		5010439317	
Poziyon/ Position		Arka / Rear	
Somun / Wheel Nut		SOM-0141	
Model			

RN-20131

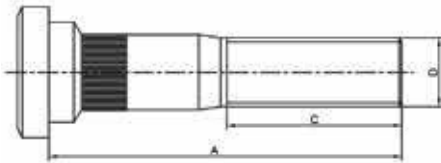

TEKNİK ÖZELLİKLER / TECHNICAL SPECIFICATION			
A(mm)	C (mm)	D (mm)	Kalite / Quality
113	56	M22x1.5	10.9
Org. No		5010566159	
Poziyon/ Position		Arka / Rear	
Somun / Wheel Nut		SOM-0141	
Model			

RN-20130

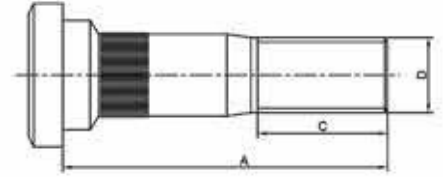

TEKNİK ÖZELLİKLER / TECHNICAL SPECIFICATION			
A(mm)	C (mm)	D (mm)	Kalite / Quality
95	38	M22x1.5	10.9
Org. No		5010566244	
Poziyon/ Position		Arka / Rear	
Somun / Wheel Nut		SOM-0141	
Model			

RN-20137

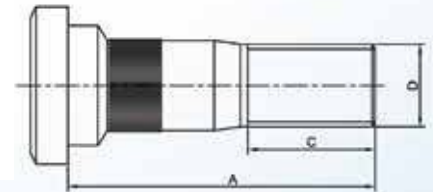

TEKNİK ÖZELLİKLER / TECHNICAL SPECIFICATION			
A(mm)	C (mm)	D (mm)	Kalite / Quality
82	34	M18x1.5	10.9
Org. No			
Poziyon/ Position		Arka / Rear	
Somun / Wheel Nut		SOM-0120	
Model			

RN-20140

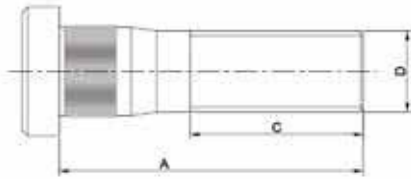

TEKNİK ÖZELLİKLER / TECHNICAL SPECIFICATION

A(mm)	C (mm)	D (mm)	Kalite / Quality
79.5	50	M22x1.5	10.9
Org. No		7420515514	
Poziyon/ Position		Ön / Front	
Somun / Wheel Nut		SOM-0141	
Model			

RN-20141



TEKNİK ÖZELLİKLER / TECHNICAL SPECIFICATION

A(mm)	C (mm)	D (mm)	Kalite / Quality
88	68	M22x1.5	10.9
Org. No		7420515515	
Poziyon/ Position		Ön / Front	
Somun / Wheel Nut		SOM-0141	
Model			

RN-20142

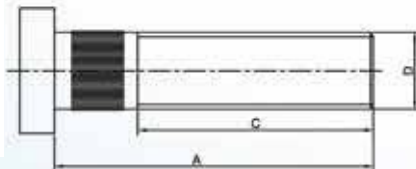

TEKNİK ÖZELLİKLER / TECHNICAL SPECIFICATION

A(mm)	C (mm)	D (mm)	Kalite / Quality
100	76	M22x1.5	10.9
Org. No		7420515518	
Poziyon/ Position		Arka / Rear	
Somun / Wheel Nut		SOM-0141	
Model			

RN-20143

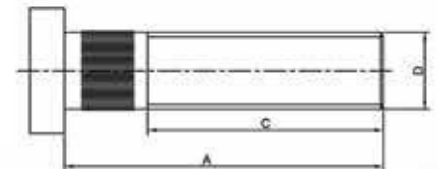

TEKNİK ÖZELLİKLER / TECHNICAL SPECIFICATION

A(mm)	C (mm)	D (mm)	Kalite / Quality
105	82	M22x1.5	10.9
Org. No		7420515519	
Poziyon/ Position		Arka / Rear	
Somun / Wheel Nut		SOM-0141	
Model			

RN-20144

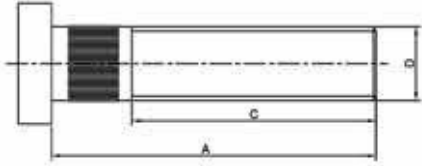

TEKNİK ÖZELLİKLER / TECHNICAL SPECIFICATION

A(mm)	C (mm)	D (mm)	Kalite / Quality
97	73	M22x1.5	10.9
Org. No		7420515517	
Poziyon/ Position		Arka / Rear	
Somun / Wheel Nut		SOM-0141	
Model			

RN-20145

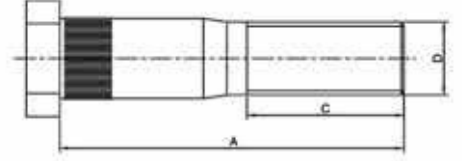

TEKNİK ÖZELLİKLER / TECHNICAL SPECIFICATION

A(mm)	C (mm)	D (mm)	Kalite / Quality
114	47	M22x1.5	10.9
Org. No		7421147687 / 21147687	
Poziyon/ Position		Arka / Rear	
Somun / Wheel Nut		SOM-0141	
Model			

RN-20147

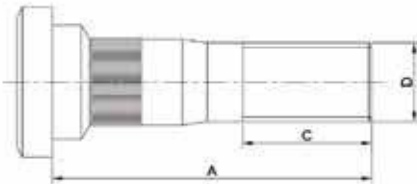

TEKNİK ÖZELLİKLER / TECHNICAL SPECIFICATION

A(mm)	C (mm)	D (mm)	Kalite / Quality
81.5	33	M20x1.5	10.9
Org. No		5010319277	
Poziyon/ Position		Ön / Front	
Somun / Wheel Nut		SOM-0131	
Model		MIDLUM	

RN-20148

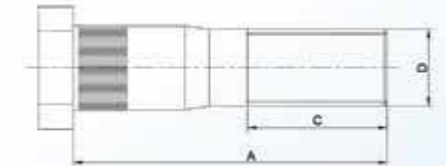

TEKNİK ÖZELLİKLER / TECHNICAL SPECIFICATION

A(mm)	C (mm)	D (mm)	Kalite / Quality
90	40	M22x1.5	10.9
Org. No		5010319709	
Poziyon/ Position		Arka / Rear	
Somun / Wheel Nut		SOM-0141	
Model			

RN-20149



TEKNİK ÖZELLİKLER / TECHNICAL SPECIFICATION			
A(mm)	C (mm)	D (mm)	Kalite / Quality
133	72	M22x1.5	10.9
Org. No		5010439406	
Poziyon/ Position		Arka / Rear	
Somun / Wheel Nut		SOM-0141	
Model			

RN-20150

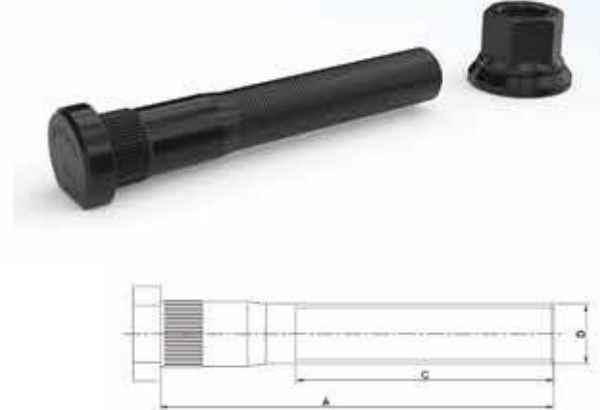

TEKNİK ÖZELLİKLER / TECHNICAL SPECIFICATION			
A(mm)	C (mm)	D (mm)	Kalite / Quality
145	95	M22x1.5	10.9
Org. No			
Poziyon/ Position		Arka / Rear	
Somun / Wheel Nut		SOM-0141	
Model			

RN-20151



TEKNİK ÖZELLİKLER / TECHNICAL SPECIFICATION			
A(mm)	C (mm)	D (mm)	Kalite / Quality
	31	M18x1.5	10.9
Org. No		5010241839	
Poziyon/ Position		Ön / Front	
Somun / Wheel Nut		SOM-0120	
Model			

RN-20152



TEKNİK ÖZELLİKLER / TECHNICAL SPECIFICATION			
A(mm)	C (mm)	D (mm)	Kalite / Quality
92	68	M22x1.5	10.9
Org. No		7420515516	
Poziyon/ Position		Ön / Front	
Somun / Wheel Nut		SOM-0141	
Model			

RN-20153

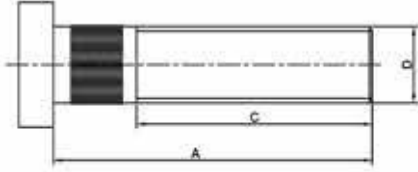

TEKNİK ÖZELLİKLER / TECHNICAL SPECIFICATION			
A(mm)	C (mm)	D (mm)	Kalite / Quality
122	100	M22x1.5	10.9
Org. No		7420553560	
Poziyon/ Position		Arka / Rear	
Somun / Wheel Nut		SOM-0141	
Model			

RN-20154



TEKNİK ÖZELLİKLER / TECHNICAL SPECIFICATION			
A(mm)	C (mm)	D (mm)	Kalite / Quality
130	41	M22x1.5	10.9
Org. No		7420489851	
Poziyon/ Position		Arka / Rear	
Somun / Wheel Nut		SOM-0141	
Model			

RN-20155

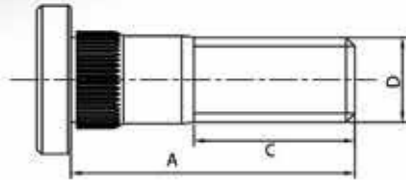

TEKNİK ÖZELLİKLER / TECHNICAL SPECIFICATION			
A(mm)	C (mm)	D (mm)	Kalite / Quality
50	30	M20x1.5	10.9
Org. No		5010224821	
Poziyon/ Position		Ön / Front	
Somun / Wheel Nut		SOM-0131	
Model			

RN-20156

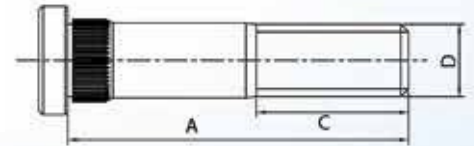

TEKNİK ÖZELLİKLER / TECHNICAL SPECIFICATION			
A(mm)	C (mm)	D (mm)	Kalite / Quality
95	40	M20x1.5	10.9
Org. No			
Poziyon/ Position		Arka / Rear	
Somun / Wheel Nut		SOM-0131	
Model			

DRS-30168

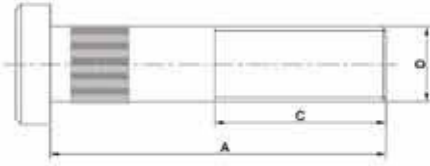

TEKNİK ÖZELLİKLER / TECHNICAL SPECIFICATION			
A(mm)	C (mm)	D (mm)	Kalite / Quality
98	48.5	M22x1.5	10.9
Org. No		21020977 / 21020997	
Poziyon/ Position			
Somun / Wheel Nut		SOM-0141	
Model			

DRS-30169-L

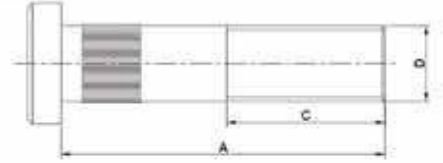

TEKNİK ÖZELLİKLER / TECHNICAL SPECIFICATION			
A(mm)	C (mm)	D (mm)	Kalite / Quality
94	46	W7/8"x11	10.9
Org. No		21018491	
Poziyon/ Position			
Somun / Wheel Nut		SOM-0170-L	
Model			

DRS-30169-R

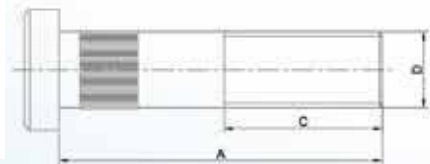

TEKNİK ÖZELLİKLER / TECHNICAL SPECIFICATION			
A(mm)	C (mm)	D (mm)	Kalite / Quality
94	46	W7/8"x11	10.9
Org. No		210 184 90	
Poziyon/ Position			
Somun / Wheel Nut		SOM-0170	
Model			

DRS-30170

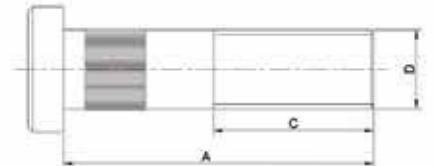

TEKNİK ÖZELLİKLER / TECHNICAL SPECIFICATION			
A(mm)	C (mm)	D (mm)	Kalite / Quality
85	50	M22x1.5	10.9
Org. No		21022167	
Poziyon/ Position			
Somun / Wheel Nut		SOM-0141	
Model			

DRS-30171

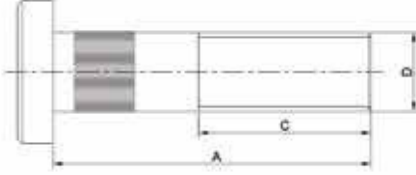

TEKNİK ÖZELLİKLER / TECHNICAL SPECIFICATION

A(mm)	C (mm)	D (mm)	Kalite / Quality
80	45	M22x1.5	10.9
Org. No		21220132	
Poziyon/ Position			
Somun / Wheel Nut		SOM-0141	
Model		ROR	

DRS-30202

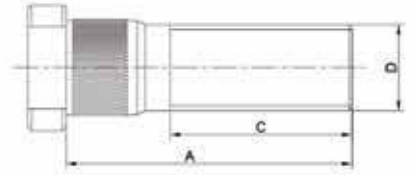

TEKNİK ÖZELLİKLER / TECHNICAL SPECIFICATION

A(mm)	C (mm)	D (mm)	Kalite / Quality
73	46.5	M22x1.5	10.9
Org. No		1 303 1118 10	
Poziyon/ Position			
Somun / Wheel Nut		SOM-0140	
Model			

DRS-30203

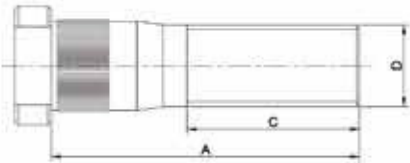

TEKNİK ÖZELLİKLER / TECHNICAL SPECIFICATION

A(mm)	C (mm)	D (mm)	Kalite / Quality
83	46.5	M22x1.5	10.9
Org. No		1303 10 74 12	
Poziyon/ Position			
Somun / Wheel Nut		SOM-0141	
Model			

DRS-30204

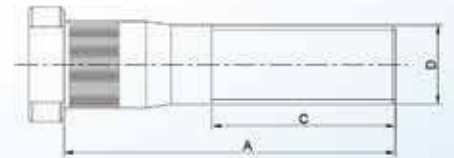

TEKNİK ÖZELLİKLER / TECHNICAL SPECIFICATION

A(mm)	C (mm)	D (mm)	Kalite / Quality
93	51.5	M22x1.5	10.9
Org. No		1 303 10 75 12	
Poziyon/ Position			
Somun / Wheel Nut		SOM-0141	
Model			

DRS-30205

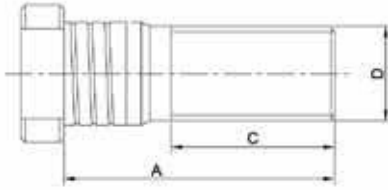

TEKNİK ÖZELLİKLER / TECHNICAL SPECIFICATION			
A(mm)	C (mm)	D (mm)	Kalite / Quality
83	38	M22x1.5	10.9
Org. No			
Poziyon/ Position			
Somun / Wheel Nut		SOM-0141	
Model			

DRS-30208

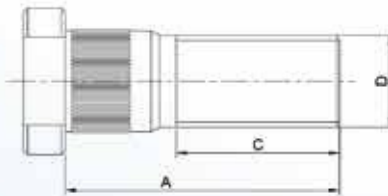

TEKNİK ÖZELLİKLER / TECHNICAL SPECIFICATION			
A(mm)	C (mm)	D (mm)	Kalite / Quality
65.5	39	M22x1.5	10.9
Org. No			
Poziyon/ Position			
Somun / Wheel Nut		SOM-0140	
Model			

DRS-30207

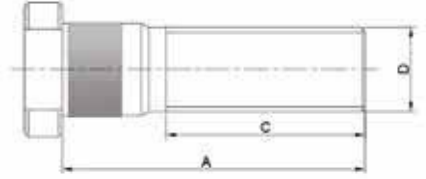

TEKNİK ÖZELLİKLER / TECHNICAL SPECIFICATION			
A(mm)	C (mm)	D (mm)	Kalite / Quality
79	52	M22x1.5	10.9
Org. No		1303112010	
Poziyon/ Position			
Somun / Wheel Nut		SOM-0140	
Model			

DRS-30209

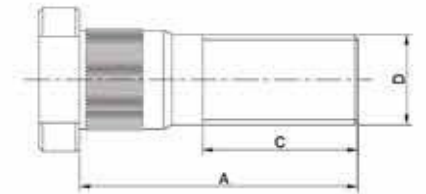

TEKNİK ÖZELLİKLER / TECHNICAL SPECIFICATION			
A(mm)	C (mm)	D (mm)	Kalite / Quality
68	38	M22x1.5	10.9
Org. No		1 303 118 11	
Poziyon/ Position			
Somun / Wheel Nut		SOM-0140	
Model			

DRS-30210

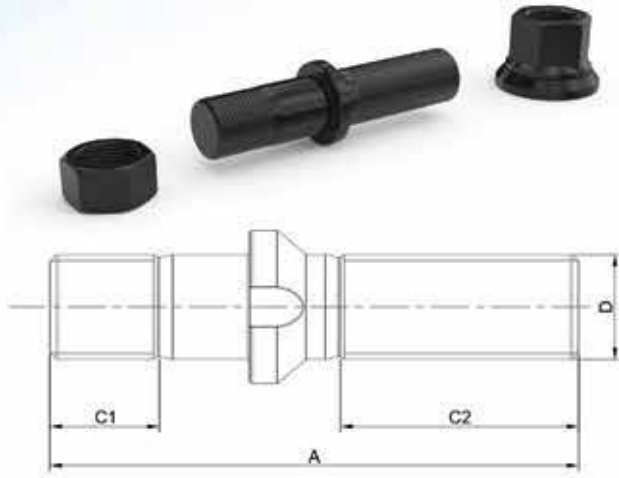

TEKNİK ÖZELLİKLER / TECHNICAL SPECIFICATION			
A(mm)	C (mm)	D (mm)	Kalite / Quality
111	23-50	M22x1.5	10.9
Org. No		1 303 10 40 11 / 1 303 1049 10 / 1 303 1040 10	
Poziyon/ Position			
Somun / Wheel Nut		SOM-0450 / SOM-0141	
Model		SAF	

DRS-30211

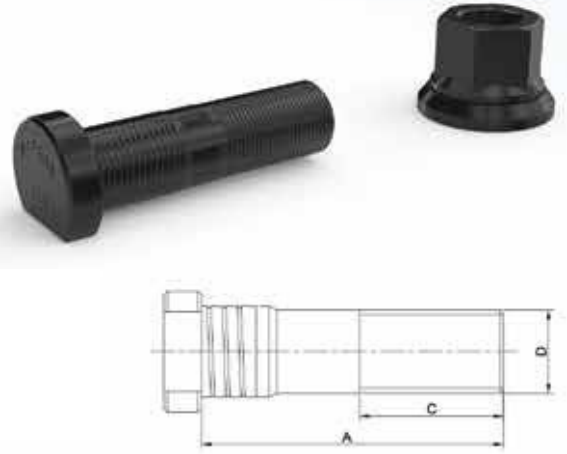

TEKNİK ÖZELLİKLER / TECHNICAL SPECIFICATION			
A(mm)	C (mm)	D (mm)	Kalite / Quality
80	38	M22x1.5	10.9
Org. No			
Poziyon/ Position			
Somun / Wheel Nut		SOM-0140	
Model			

DRS-30212

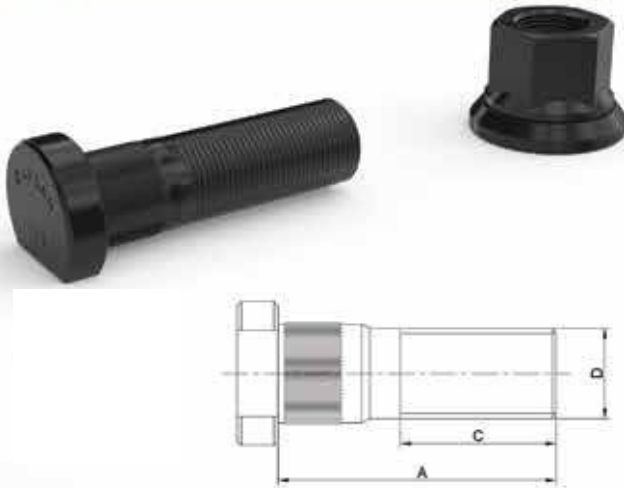

TEKNİK ÖZELLİKLER / TECHNICAL SPECIFICATION			
A(mm)	C (mm)	D (mm)	Kalite / Quality
75	50	M22x1.5	10.9
Org. No			
Poziyon/ Position			
Somun / Wheel Nut		SOM-0140	
Model		SAF DORSE	

MIT-AB12-L

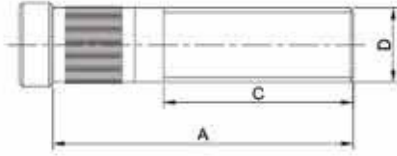

TEKNİK ÖZELLİKLER / TECHNICAL SPECIFICATION

A(mm)	C (mm)	D (mm)	Kalite / Quality
52	33	M16X1.5	10.9
Org. No			
Poziyon/ Position			
Somun / Wheel Nut		MIT-AB14-L	
Model		304 - 515	

MIT-AB12-R

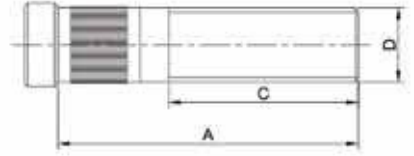

TEKNİK ÖZELLİKLER / TECHNICAL SPECIFICATION

A(mm)	C (mm)	D (mm)	Kalite / Quality
42	33	M16X1.5	10.9
Org. No			
Poziyon/ Position			
Somun / Wheel Nut		MIT-AB-14-R	
Model		304 - 515	

MIT-AB16-L

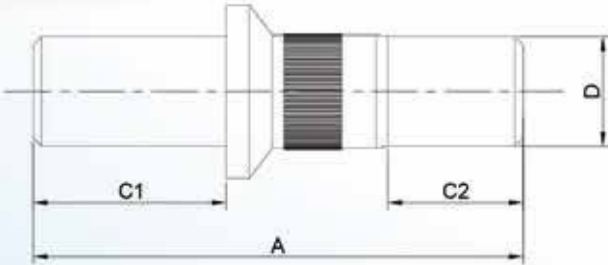

TEKNİK ÖZELLİKLER / TECHNICAL SPECIFICATION

A(mm)	C (mm)	D (mm)	Kalite / Quality
85	30 - 24	M19x1.5- 3/4"x16	10.9
Org. No			
Poziyon/ Position		Ön / Front	
Somun / Wheel Nut		MIT-AB23 / MIT-AB21-L	
Model		444-635-835	

MIT-AB16-R

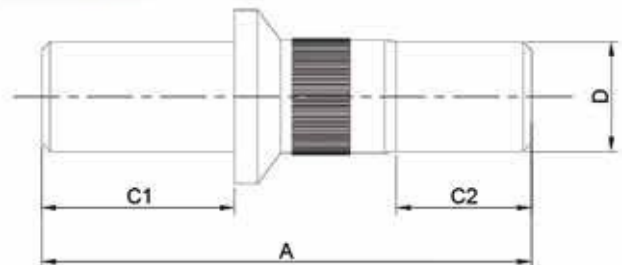

TEKNİK ÖZELLİKLER / TECHNICAL SPECIFICATION

A(mm)	C (mm)	D (mm)	Kalite / Quality
85	30 - 24	M19x1.5 3/4"x16	10.9
Org. No			
Poziyon/ Position		Ön / Front	
Somun / Wheel Nut		MIT-AB23 / MIT-AB21-R	
Model		444-635-835	

MIT-AB17-L

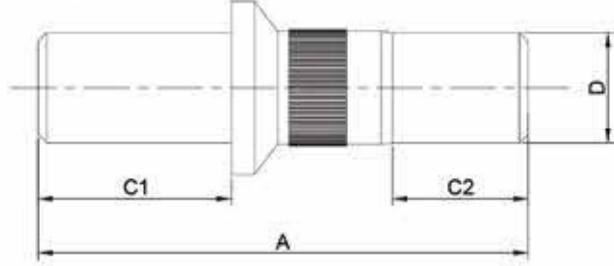

TEKNİK ÖZELLİKLER / TECHNICAL SPECIFICATION

A(mm)	C (mm)	D (mm)	Kalite / Quality
85	24- 30	3/4"x16 -M19x1.5	10.9
Org. No			
Poziyon/ Position		Arka / Rear	
Somun / Wheel Nut		MIT-AB23 / MIT-AB22-L	
Model		444 - 635 - 835	

MIT-AB17-R

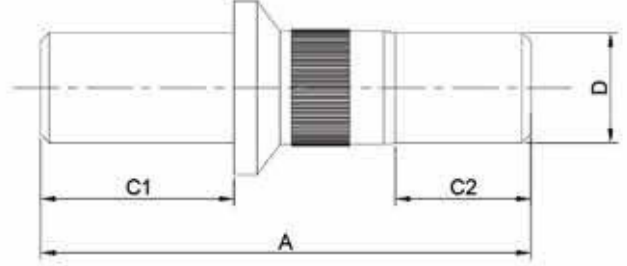

TEKNİK ÖZELLİKLER / TECHNICAL SPECIFICATION

A(mm)	C (mm)	D (mm)	Kalite / Quality
85	33.5-23.5	3/4"x16 -M19x1.5	10.9
Org. No			
Poziyon/ Position		Arka / Rear	
Somun / Wheel Nut		MIT-AB23 / MIT-AB22-R	
Model		444 - 635 - 835	

MIT-AB18-L

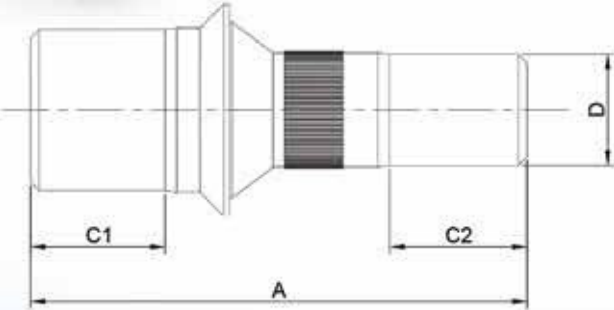

TEKNİK ÖZELLİKLER / TECHNICAL SPECIFICATION

A(mm)	C (mm)	D (mm)	Kalite / Quality
99	24 - 36	3/4"x16 -M28x1.5	10.9
Org. No			
Poziyon/ Position			
Somun / Wheel Nut		MIT-AB23 / MIT-AB22-L	
Model		444-635-835	

MIT-AB18-R

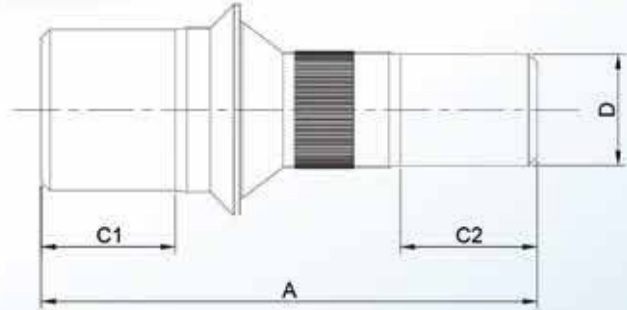

TEKNİK ÖZELLİKLER / TECHNICAL SPECIFICATION

A(mm)	C (mm)	D (mm)	Kalite / Quality
99	24 - 36	3/4"x16 -M28x1.5	10.9
Org. No			
Poziyon/ Position			
Somun / Wheel Nut		MIT-AB23 / MIT-AB22-R	
Model		444-635-835	

MIT-AB24-L

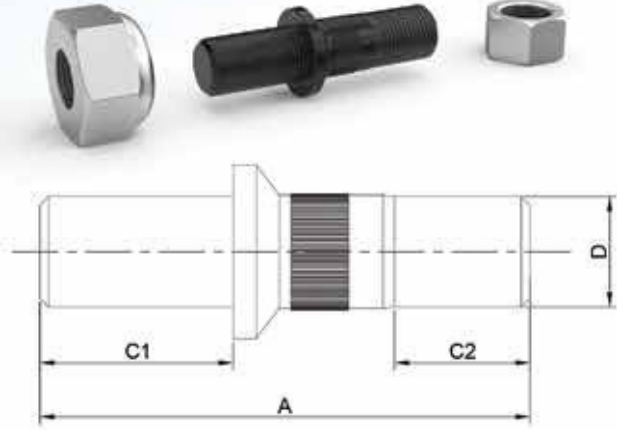

TEKNİK ÖZELLİKLER / TECHNICAL SPECIFICATION

A(mm)	C (mm)	D (mm)	Kalite / Quality
85	30 - 24	3/4"x16 -M20x1.5	10.9
Org. No			
Poziyon/ Position		Ön / Front	
Somun / Wheel Nut		MIT-AB31 / MIT-AB29-L	
Model		449-659-859	

MIT-AB24-R

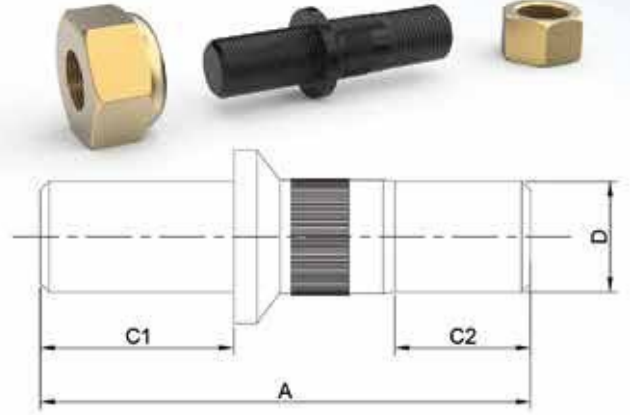

TEKNİK ÖZELLİKLER / TECHNICAL SPECIFICATION

A(mm)	C (mm)	D (mm)	Kalite / Quality
85	30 - 24	3/4"x16 -M20x1.5	10.9
Org. No			
Poziyon/ Position		Ön / Front	
Somun / Wheel Nut		MIT-AB31 / MIT-AB29-R	
Model		449-659-859	

MIT-AB25-L

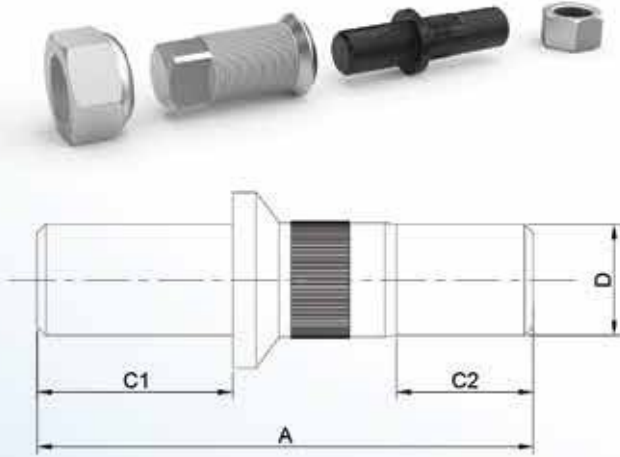

TEKNİK ÖZELLİKLER / TECHNICAL SPECIFICATION

A(mm)	C (mm)	D (mm)	Kalite / Quality
85	24 - 30	3/4"x16 -M20x1.5	10.9
Org. No			
Poziyon/ Position		Arka / Rear	
Somun / Wheel Nut		MIT-AB31 / MIT-AB30-L	
Model		449-659-859	

MIT-AB25-R

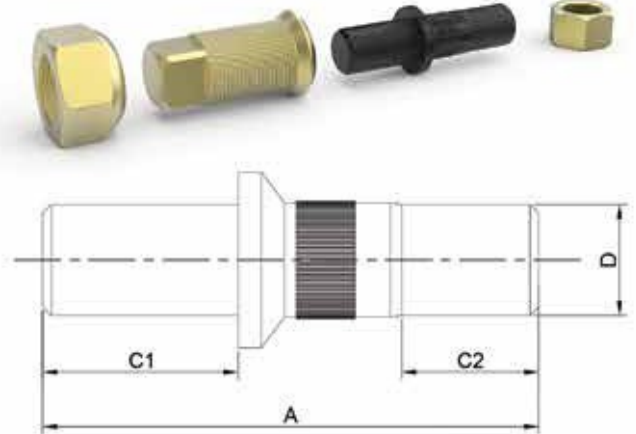

TEKNİK ÖZELLİKLER / TECHNICAL SPECIFICATION

A(mm)	C (mm)	D (mm)	Kalite / Quality
85	24 - 30	3/4"x16 -M20x1.5	10.9
Org. No			
Poziyon/ Position		Arka / Rear	
Somun / Wheel Nut		MIT-AB31 / MITAB30-R	
Model		449-659-859	

MIT-AB26-L

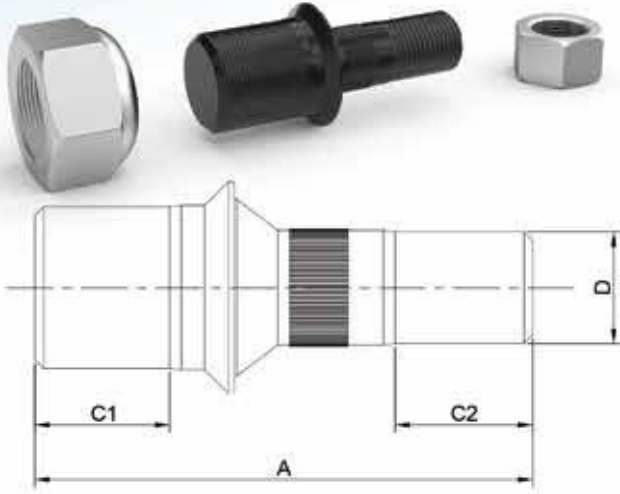

TEKNİK ÖZELLİKLER / TECHNICAL SPECIFICATION			
A(mm)	C (mm)	D (mm)	Kalite / Quality
103	24 - 40	3/4"x16 -M30x1.5	10.9
Org. No			
Poziyon/ Position		Arka / Rear	
Somun / Wheel Nut		MIT-AB31 / MIT-AB30-L	
Model		449-659-859	

MIT-AB26-R

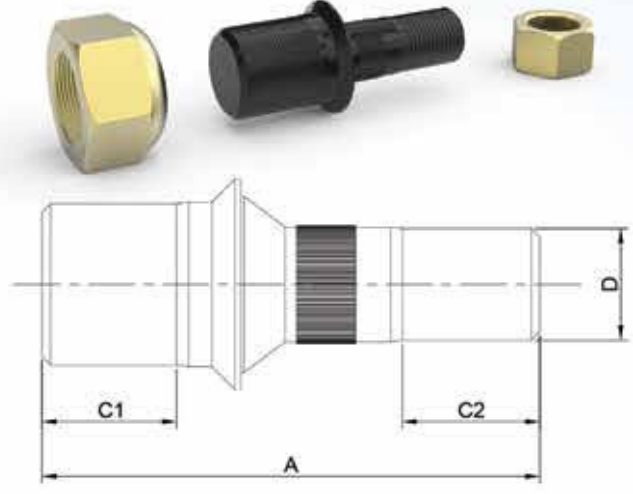

TEKNİK ÖZELLİKLER / TECHNICAL SPECIFICATION			
A(mm)	C (mm)	D (mm)	Kalite / Quality
103	24 - 40	3/4"x16 -M30x1.5	10.9
Org. No			
Poziyon/ Position		Arka / Rear	
Somun / Wheel Nut		MIT-AB-31 / MIT-AB30-R	
Model		449 - 659 - 859	

MIT-AB85

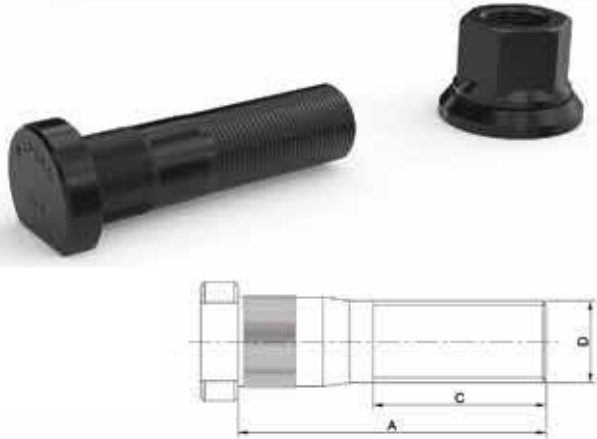

TEKNİK ÖZELLİKLER / TECHNICAL SPECIFICATION			
A(mm)	C (mm)	D (mm)	Kalite / Quality
73	46	22X1.5	10.9
Org. No			
Poziyon/ Position		Ön / Front	
Somun / Wheel Nut		SOM-0140	
Model		TEMSA - SAFİR	

MIT-AB86

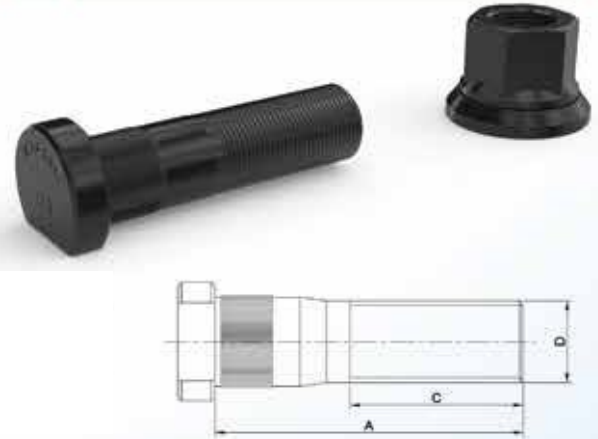

TEKNİK ÖZELLİKLER / TECHNICAL SPECIFICATION			
A(mm)	C (mm)	D (mm)	Kalite / Quality
90	52	M22x1.5	10.9
Org. No			
Poziyon/ Position		Arka / Rear	
Somun / Wheel Nut		SOM-0141	
Model		TEMSA - SAFİR	

MIT-AB95

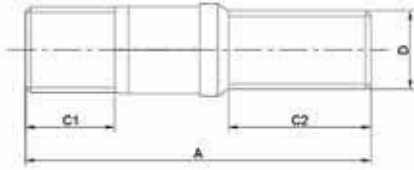

TEKNİK ÖZELLİKLER / TECHNICAL SPECIFICATION

A(mm)	C (mm)	D (mm)	Kalite / Quality
97	25-40	M24x15 / M22x1.5	10.9
Org. No		MC-808846	
Pozisyon/ Position		Ön / Front	
Somun / Wheel Nut		SOM-0401 / SOM-0141	
Model		MARATON	

MIT-AB96

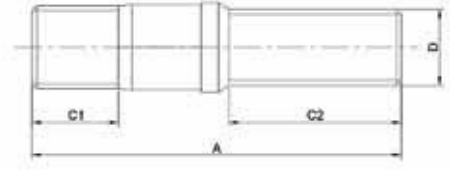

TEKNİK ÖZELLİKLER / TECHNICAL SPECIFICATION

A(mm)	C (mm)	D (mm)	Kalite / Quality
107	25-50	M24x15 / M22x1.5	10.9
Org. No		MC-808847	
Pozisyon/ Position		Arka / Rear	
Somun / Wheel Nut		SOM-0461 / SOM-0141	
Model		MARATON	

MIT-AB45-R-L

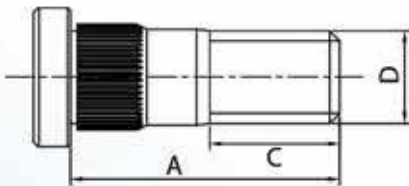

TEKNİK ÖZELLİKLER / TECHNICAL SPECIFICATION

A(mm)	C (mm)	D (mm)	Kalite / Quality
58	28	M20x1.5	10.9
Org. No			
Pozisyon/ Position		Ön / Front	
Somun / Wheel Nut		MIT-AB29-R-L	
Model		EURO 5	

MIT-AB46-R-L

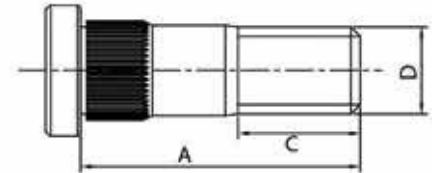

TEKNİK ÖZELLİKLER / TECHNICAL SPECIFICATION

A(mm)	C (mm)	D (mm)	Kalite / Quality
64	28	M20x1.5	10.9
Org. No			
Pozisyon/ Position		Arka / Rear	
Somun / Wheel Nut		MIT-AB30-R-L / MIT-AB27-R-L	
Model		EURO 5	

ISB-AB01-L

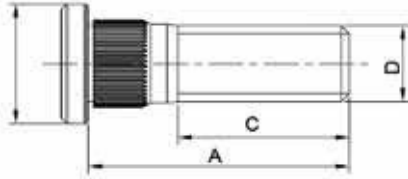

TEKNİK ÖZELLİKLER / TECHNICAL SPECIFICATION			
A(mm)	C (mm)	D (mm)	Kalite / Quality
48	32	M14X1.5	10.9
Org. No			
Poziyon/ Position			
Somun / Wheel Nut		ISB-AB02-L	
Model		NKR 13	

ISB-AB01-R

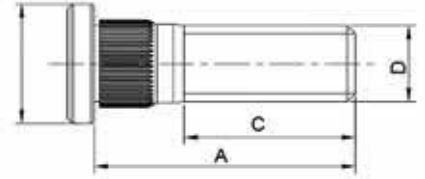

TEKNİK ÖZELLİKLER / TECHNICAL SPECIFICATION			
A(mm)	C (mm)	D (mm)	Kalite / Quality
48	32	M14X1.5	10.9
Org. No			
Poziyon/ Position			
Somun / Wheel Nut		ISB-AB02-R	
Model		NKR 13	

ISB-AB03-L

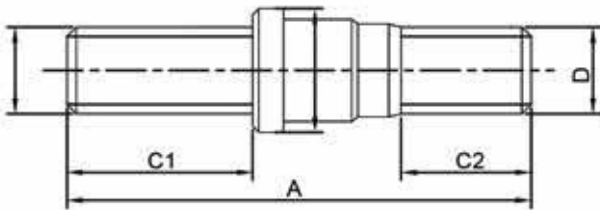

TEKNİK ÖZELLİKLER / TECHNICAL SPECIFICATION			
A(mm)	C (mm)	D (mm)	Kalite / Quality
75	29 - 21	M14X1.5	10.9
Org. No			
Poziyon/ Position		Ön / Front	
Somun / Wheel Nut		ISB-AB32 / ISB-AB29-L	
Model		NKR 55	

ISB-AB03-R

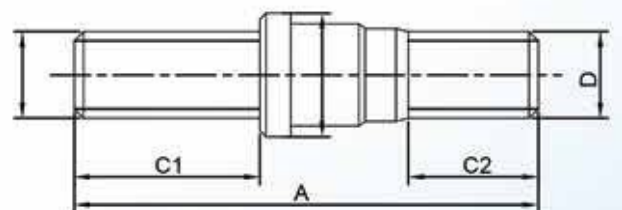

TEKNİK ÖZELLİKLER / TECHNICAL SPECIFICATION			
A(mm)	C (mm)	D (mm)	Kalite / Quality
75	29-21	M14X1.5	10.9
Org. No			
Poziyon/ Position		Ön / Front	
Somun / Wheel Nut		ISB-AB32 / ISB-AB29-R	
Model		NKR 55	

ISB-AB06-L

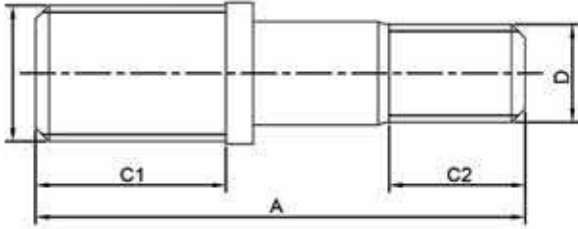

TEKNİK ÖZELLİKLER / TECHNICAL SPECIFICATION			
A(mm)	C (mm)	D (mm)	Kalite / Quality
90	36 - 23	M18X1.5 M25x1.5	10.9
Org. No			
Pozisyon/ Position		Ön / Front	
Somun / Wheel Nut		ISB-AB12 / ISB-AB11-L	
Model		NPR 59	

ISB-AB06-R

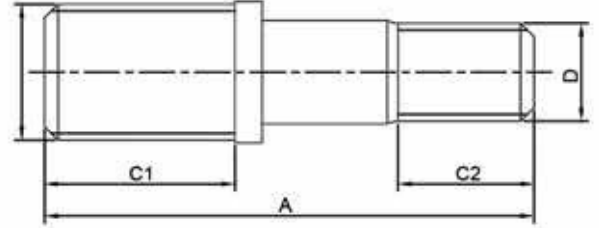

TEKNİK ÖZELLİKLER / TECHNICAL SPECIFICATION			
A(mm)	C (mm)	D (mm)	Kalite / Quality
90	36 - 23	M18x1.5 M25X1.5	10.9
Org. No			
Pozisyon/ Position		Ön / Front	
Somun / Wheel Nut		ISB-AB12 / ISB-AB11-R	
Model		NPR 59	

ISB-AB07-L

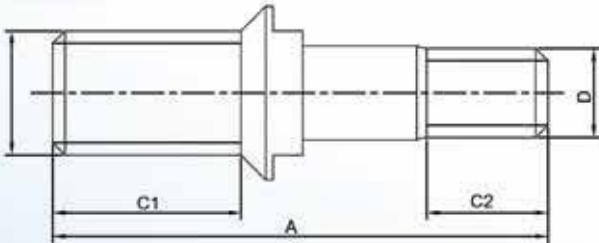

TEKNİK ÖZELLİKLER / TECHNICAL SPECIFICATION			
A(mm)	C (mm)	D (mm)	Kalite / Quality
100	39 - 25	M18x1.5 M25x1.5	10.9
Org. No			
Pozisyon/ Position		Arka / Rear	
Somun / Wheel Nut		ISB-AB12 / ISB-AB11-L	
Model		NPR	

ISB-AB07-R

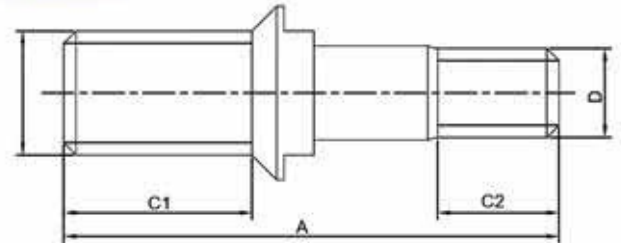

TEKNİK ÖZELLİKLER / TECHNICAL SPECIFICATION			
A(mm)	C (mm)	D (mm)	Kalite / Quality
100	39 - 25	M18x1.5 M25x1.5	10.9
Org. No			
Pozisyon/ Position		Arka / Rear	
Somun / Wheel Nut		ISB-AB12 / ISB-AB11-R	
Model		NPR	

ISB-AB08-L

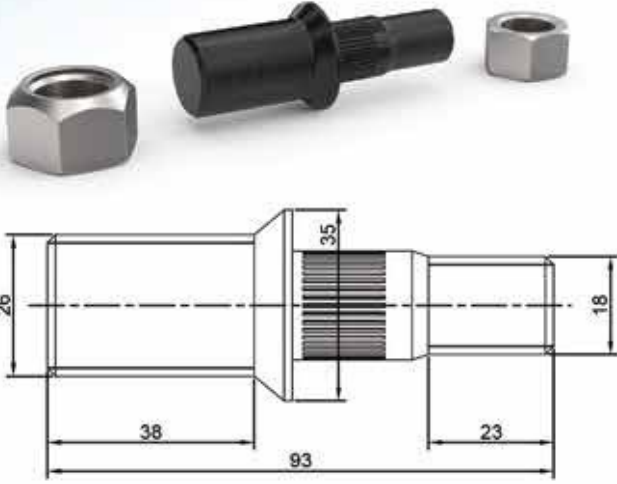

TEKNİK ÖZELLİKLER / TECHNICAL SPECIFICATION			
A(mm)	C (mm)	D (mm)	Kalite / Quality
94	38-23	M18X1.5 M25x1.5	10.9
Org. No			
Poziyon/ Position		Arka / Rear	
Somun / Wheel Nut		ISB-AB12 / ISB-AB11-L	
Model		NPR 59 Y.M.	

ISB-AB08-R

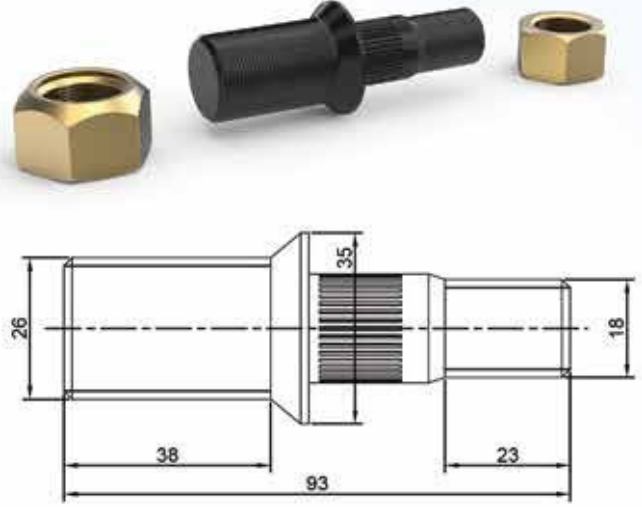

TEKNİK ÖZELLİKLER / TECHNICAL SPECIFICATION			
A(mm)	C (mm)	D (mm)	Kalite / Quality
93	38 - 23	M18x1.5 M25X1.5	10.9
Org. No			
Poziyon/ Position		Arka / Rear	
Somun / Wheel Nut		ISB-AB12 / ISB-AB11-R	
Model		NPR59 Y.M.	

ISB-AB13-L / ISB-AB18-L

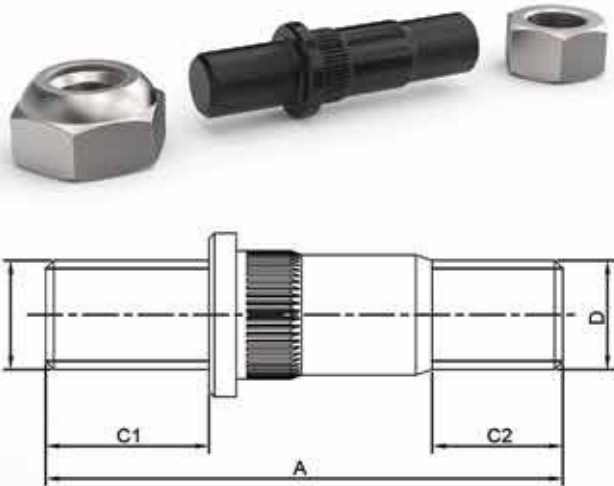

TEKNİK ÖZELLİKLER / TECHNICAL SPECIFICATION			
A(mm)	C (mm)	D (mm)	Kalite / Quality
92	29 - 24	M22X1.5 M20X1.5	10.9
Org. No			
Poziyon/ Position		Ön / Front	
Somun / Wheel Nut		ISB-AB17 / ISB-AB15-R	
Model		NPR66 / NQR	

ISB-AB13-R / ISB-AB18-R

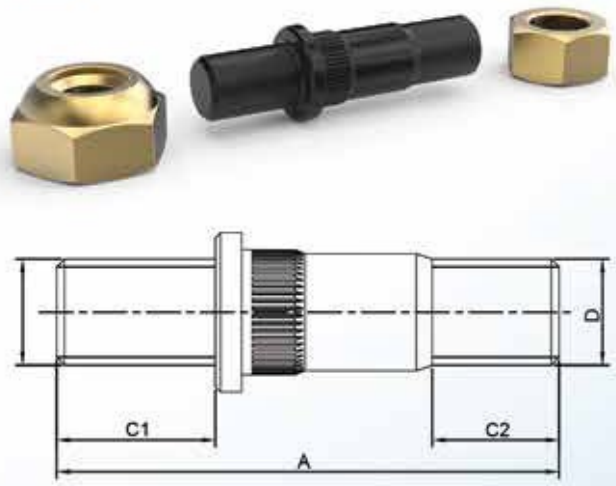

TEKNİK ÖZELLİKLER / TECHNICAL SPECIFICATION			
A(mm)	C (mm)	D (mm)	Kalite / Quality
92	29 - 24	M22X1.5 M20x1.5	10.9
Org. No			
Poziyon/ Position		Ön / Front	
Somun / Wheel Nut		ISB-AB17 / ISB-AB15-L	
Model		NPR66 / NQR	

ISB-AB14-L

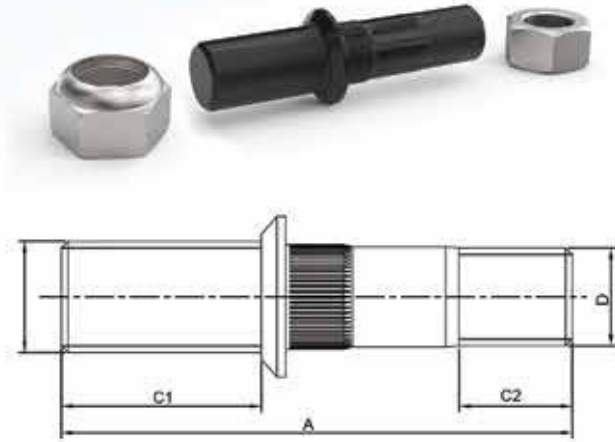

TEKNİK ÖZELLİKLER / TECHNICAL SPECIFICATION

A(mm)	C (mm)	D (mm)	Kalite / Quality
114	43 - 27	M22X1.5 M25x1.5	10.9
Org. No			
Poziyon/ Position		Arka / Rear	
Somun / Wheel Nut		ISB-AB17 / ISB-AB16-L	
Model		NPR66 CHAMPION	

ISB-AB14-R

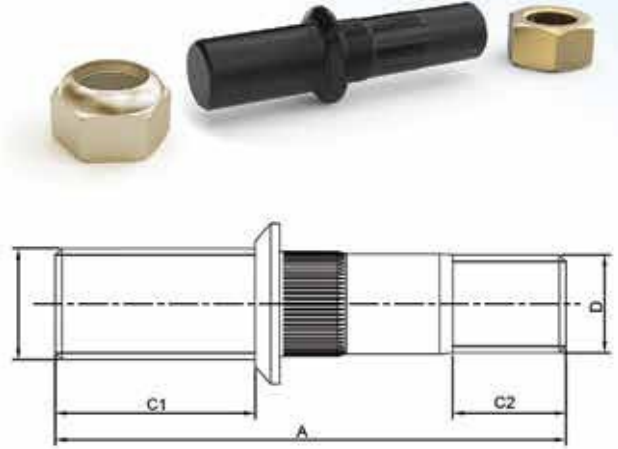

TEKNİK ÖZELLİKLER / TECHNICAL SPECIFICATION

A(mm)	C (mm)	D (mm)	Kalite / Quality
114	43 - 27	M22X1.5 M25x1.5	10.9
Org. No			
Poziyon/ Position		Arka / Rear	
Somun / Wheel Nut		ISB-AB17 / ISB-AB16-L	
Model		NPR66 CHAMPION	

ISB-AB19-L

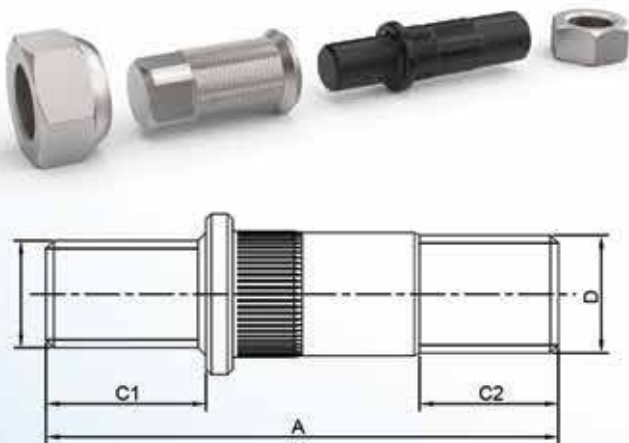

TEKNİK ÖZELLİKLER / TECHNICAL SPECIFICATION

A(mm)	C (mm)	D (mm)	Kalite / Quality
93	30 - 26	M22x1.5 M20x1.5	10.9
Org. No			
Poziyon/ Position		Arka / Rear	
Somun / Wheel Nut		ISB-AB23 / ISB-AB22-L	
Model		NQR TURKUAZ	

ISB-AB19-R

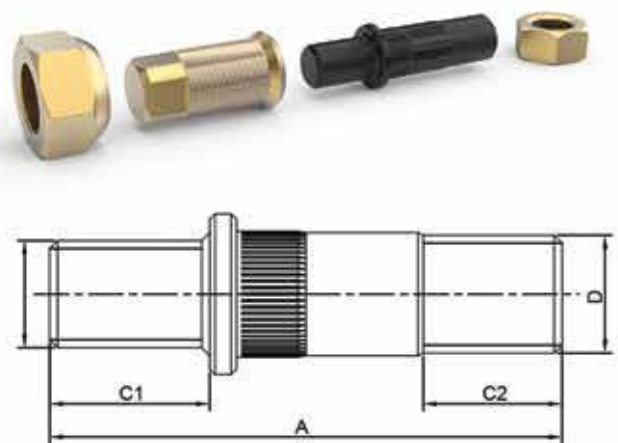

TEKNİK ÖZELLİKLER / TECHNICAL SPECIFICATION

A(mm)	C (mm)	D (mm)	Kalite / Quality
93	30 - 26	M22x1.5 M20x1.5	10.9
Org. No			
Poziyon/ Position		Arka / Rear	
Somun / Wheel Nut		ISB-AB23 / ISB-AB22-R	
Model		NQR TURKUAZ	

ISB-AB28-L

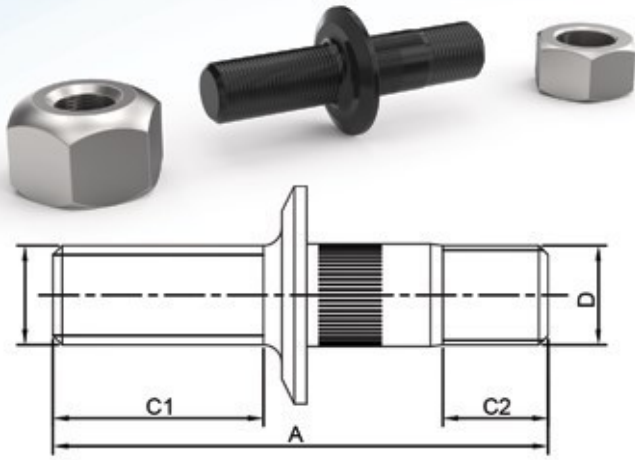

TEKNİK ÖZELLİKLER / TECHNICAL SPECIFICATION

A(mm)	C (mm)	D (mm)	Kalite / Quality
80	35 - 17	M16X1.5 M16x1.5	10.9
Org. No			
Poziyon/ Position		Arka / Rear	
Somun / Wheel Nut		ISB-AB05 / ISB-AB04-L	
Model		NKR 55	

ISB-AB28-R

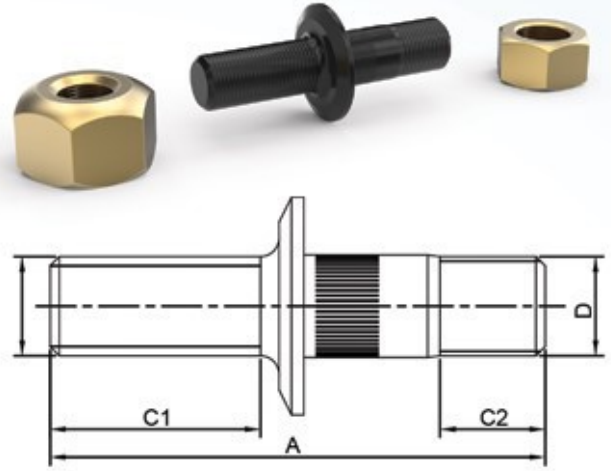

TEKNİK ÖZELLİKLER / TECHNICAL SPECIFICATION

A(mm)	C (mm)	D (mm)	Kalite / Quality
80	35 - 17	M16X1.5 M16x1.5	10.9
Org. No			
Poziyon/ Position		Arka / Rear	
Somun / Wheel Nut		ISB-AB05 / ISB-AB04-R	
Model		NKR 55	

ISB-AB30-L

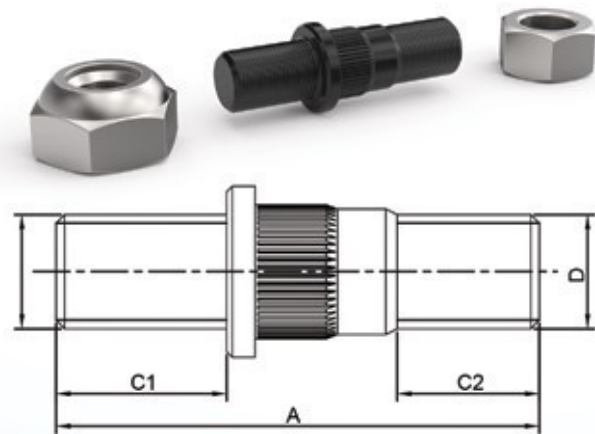

TEKNİK ÖZELLİKLER / TECHNICAL SPECIFICATION

A(mm)	C (mm)	D (mm)	Kalite / Quality
78	30 - 20	M20X1.5 M18x1.5	10.9
Org. No			
Poziyon/ Position		Ön / Front	
Somun / Wheel Nut		ISB-AB36 / ISB-AB33-L	
Model		NLR	

ISB-AB30-R

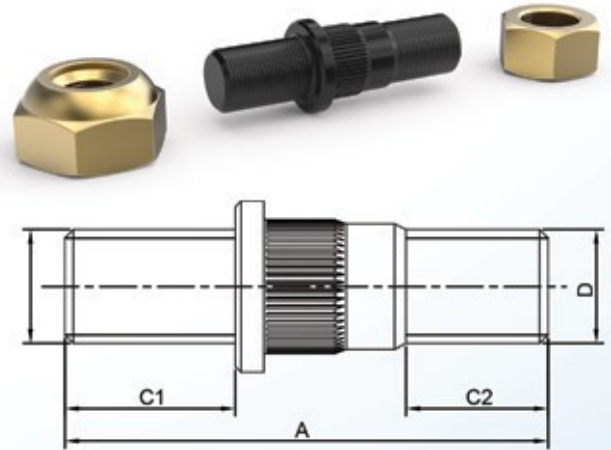

TEKNİK ÖZELLİKLER / TECHNICAL SPECIFICATION

A(mm)	C (mm)	D (mm)	Kalite / Quality
78	30 - 20	M20X1.5 M18x1.5	10.9
Org. No			
Poziyon/ Position		Ön / Front	
Somun / Wheel Nut		ISB-AB36 / ISB-AB33-R	
Model		NLR	

ISB-AB31-L

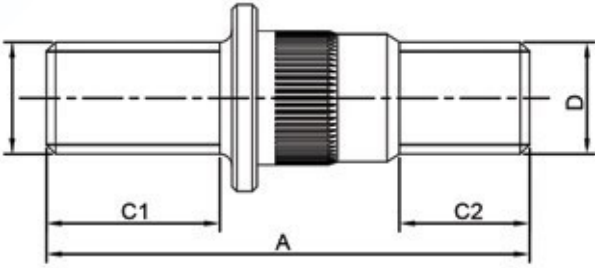

TEKNİK ÖZELLİKLER / TECHNICAL SPECIFICATION

A(mm)	C (mm)	D (mm)	Kalite / Quality
78	30 - 20	M20x1.5 M18x1.5	10.9
Org. No			
Poziyon/ Position		Arka / Rear	
Somun / Wheel Nut		ISB-AB36 / ISB-AB34-L	
Model		NLR	

ISB-AB31-L

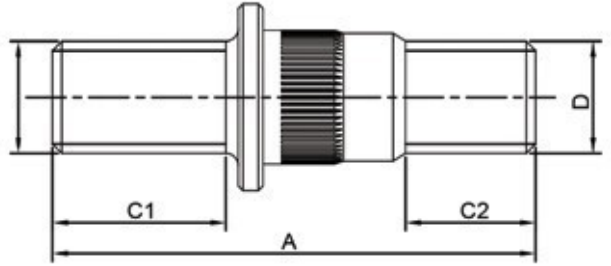

TEKNİK ÖZELLİKLER / TECHNICAL SPECIFICATION

A(mm)	C (mm)	D (mm)	Kalite / Quality
78	30 - 20	M20x1.5 M18x1.5	10.9
Org. No			
Poziyon/ Position		Arka / Rear	
Somun / Wheel Nut		ISB-AB36 / ISB-AB34-R	
Model		NLR	

ISB-AB39-L

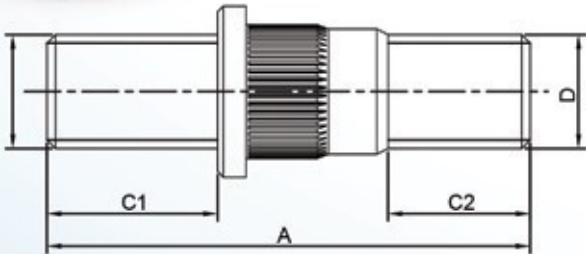

TEKNİK ÖZELLİKLER / TECHNICAL SPECIFICATION

A(mm)	C (mm)	D (mm)	Kalite / Quality
85	30 - 23	M22X1.5 M20x1.5	10.9
Org. No			
Poziyon/ Position		Ön / Front	
Somun / Wheel Nut		ISB-AB44 / ISB-AB42-L	
Model		NPR75 / NOVA	

ISB-AB39-R

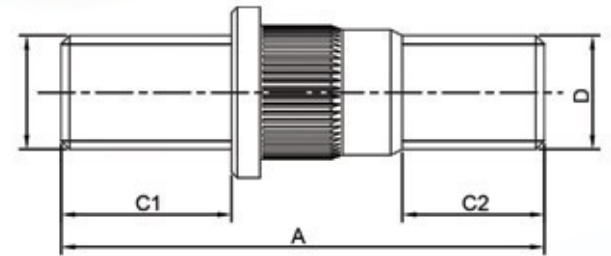

TEKNİK ÖZELLİKLER / TECHNICAL SPECIFICATION

A(mm)	C (mm)	D (mm)	Kalite / Quality
85	30 - 23	M22X1.5 M20x1.5	10.9
Org. No			
Poziyon/ Position		Ön / Front	
Somun / Wheel Nut		ISB-AB44 / ISB-AB42-R	
Model		NPR75 / NOVA	

ISB-AB40-L

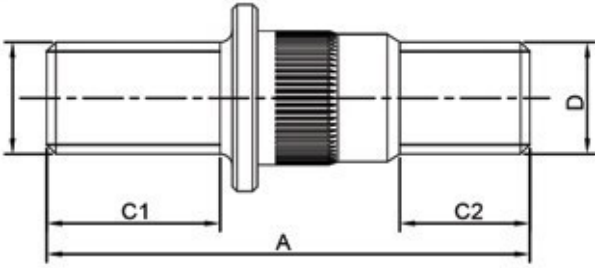

TEKNİK ÖZELLİKLER / TECHNICAL SPECIFICATION

A(mm)	C (mm)	D (mm)	Kalite / Quality
85	30 - 23	M22X1.5 M20x1.5	10.9
Org. No			
Poziyon/ Position		Arka / Rear	
Somun / Wheel Nut		ISB-AB44 / ISB-AB43-L	
Model		NOVA - NPR75	

ISB-AB40-R

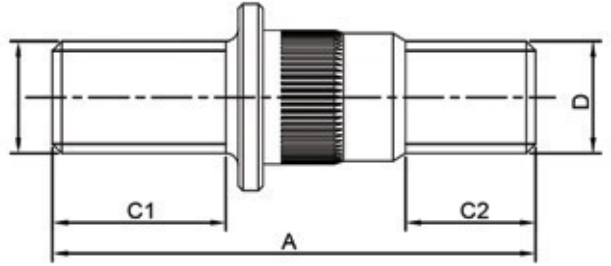

TEKNİK ÖZELLİKLER / TECHNICAL SPECIFICATION

A(mm)	C (mm)	D (mm)	Kalite / Quality
85	30 - 23	M22X1.5 M20x1.5	10.9
Org. No			
Poziyon/ Position		Arka / Rear	
Somun / Wheel Nut		ISB-AB44 / ISB-AB43-R	
Model		NOVA - NPR75	

ISB-AB48-L

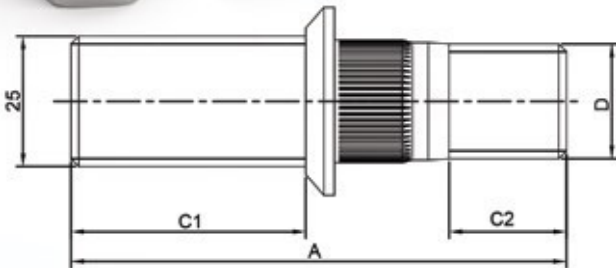

TEKNİK ÖZELLİKLER / TECHNICAL SPECIFICATION

A(mm)	C (mm)	D (mm)	Kalite / Quality
100	40 - 22	M22X1.5 M30x1.5	10.9
Org. No			
Poziyon/ Position		Arka / Rear	
Somun / Wheel Nut		ISB-AB44 / ISB-AB43-L	
Model		NOVA - NPR75	

ISB-AB48-R

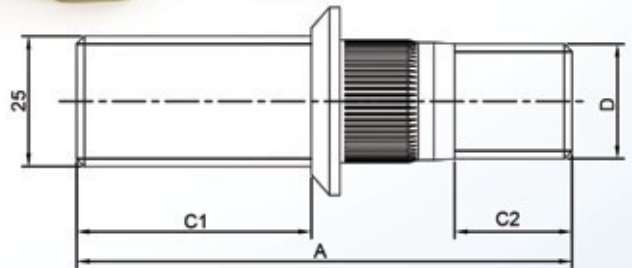

TEKNİK ÖZELLİKLER / TECHNICAL SPECIFICATION

A(mm)	C (mm)	D (mm)	Kalite / Quality
100	40 - 22	M22X1.5 M30x1.5	10.9
Org. No			
Poziyon/ Position		Arka / Rear	
Somun / Wheel Nut		ISB-AB44 / ISB-AB43-r	
Model		NOVA - NPR75	

OTK-80126

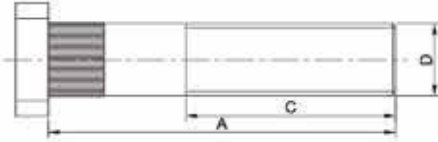

TEKNİK ÖZELLİKLER / TECHNICAL SPECIFICATION

A(mm)	C (mm)	D (mm)	Kalite / Quality
79.5	48	M18X1.5	10.9
Org. No			
Poziyon/ Position		Arka / Rear	
Somun / Wheel Nut		SOM-0320	
Model		MAGIRUS	

OTK-80127

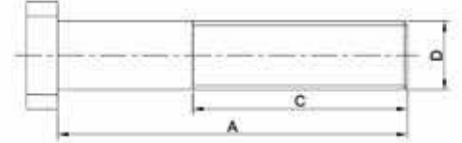

TEKNİK ÖZELLİKLER / TECHNICAL SPECIFICATION

A(mm)	C (mm)	D (mm)	Kalite / Quality
73	51.5	M18X1.5	10.9
Org. No			
Poziyon/ Position		Ön / Front	
Somun / Wheel Nut		SOM-0220	
Model			

OTK-80128

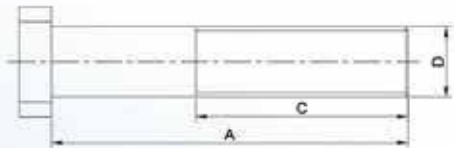

TEKNİK ÖZELLİKLER / TECHNICAL SPECIFICATION

A(mm)	C (mm)	D (mm)	Kalite / Quality
84	50	M18X1.5	10.9
Org. No		3714027071	
Poziyon/ Position		Arka / Rear	
Somun / Wheel Nut		SOM-0120	
Model		SULTAN	

OTK-80129

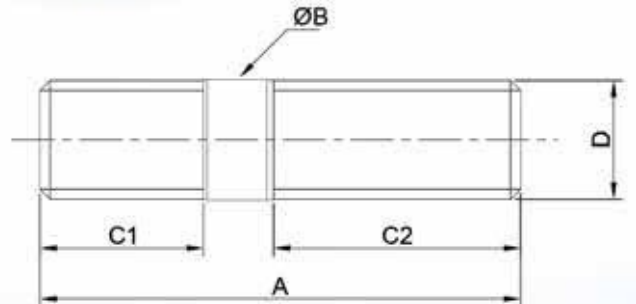

TEKNİK ÖZELLİKLER / TECHNICAL SPECIFICATION

A(mm)	C (mm)	D (mm)	Kalite / Quality
72	24.5-37	M18x1.5	10.9
Org. No			
Poziyon/ Position		Arka / Rear	
Somun / Wheel Nut		SOM-0320	
Model		MAGIRUS	

OTK-80130

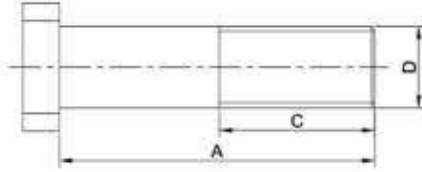

TEKNİK ÖZELLİKLER / TECHNICAL SPECIFICATION			
A(mm)	C (mm)	D (mm)	Kalite / Quality
64	31.5	M18X1.5	10.9
Org. No			
Pozisyon/ Position	Arka / Rear		
Somun / Wheel Nut	SOM-0220		
Model			

FW-101102



TEKNİK ÖZELLİKLER / TECHNICAL SPECIFICATION			
A(mm)	C (mm)	D (mm)	Kalite / Quality
119	60	M22x1.5	10.9
Org. No			
Pozisyon/ Position	Arka / Rear		
Somun / Wheel Nut	SOM-0141		
Model	FAW		

CHR-4136

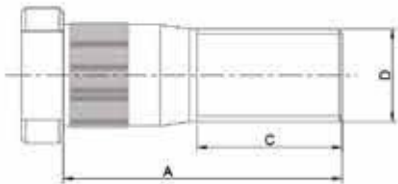

TEKNİK ÖZELLİKLER / TECHNICAL SPECIFICATION			
A(mm)	C (mm)	D (mm)	Kalite / Quality
73	38	M20x1.5	10.9
Org. No			
Pozisyon/ Position	--		
Somun / Wheel Nut	SOM-0332		
Model			

CHR-5135

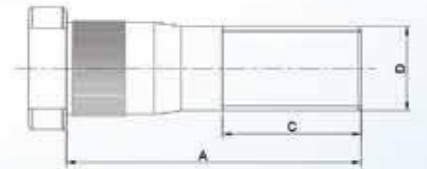

TEKNİK ÖZELLİKLER / TECHNICAL SPECIFICATION			
A(mm)	C (mm)	D (mm)	Kalite / Quality
85	40	M20x1.5	10.9
Org. No			
Pozisyon/ Position	--		
Somun / Wheel Nut	SOM-0332		
Model			

HW-90125

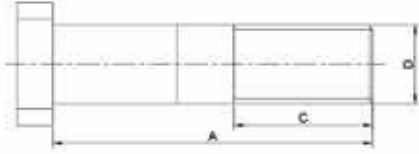

TEKNİK ÖZELLİKLER / TECHNICAL SPECIFICATION

A(mm)	C (mm)	D (mm)	Kalite / Quality
90	39	M22x1.5	10.9
Org. No			
Poziyon/ Position		Ön / Front	
Somun / Wheel Nut		SOM-0141	
Model		HOWO	

HW-90126



TEKNİK ÖZELLİKLER / TECHNICAL SPECIFICATION

A(mm)	C (mm)	D (mm)	Kalite / Quality
112	39	M22x1.5	10.9
Org. No			
Poziyon/ Position		Arka / Rear	
Somun / Wheel Nut		SOM-0141	
Model		HOWO	

KM-0515



TEKNİK ÖZELLİKLER / TECHNICAL SPECIFICATION

A(mm)	C (mm)	D (mm)	Kalite / Quality
65	38	M20x1.5	10.9
Org. No			
Poziyon/ Position			
Somun / Wheel Nut		SOM-0332	
Model		KOMATSU	

KM-0516

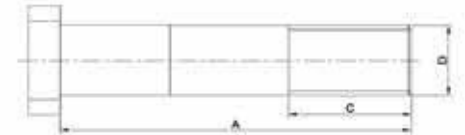

TEKNİK ÖZELLİKLER / TECHNICAL SPECIFICATION

A(mm)	C (mm)	D (mm)	Kalite / Quality
75	43	M20x1.5	10.9
Org. No			
Poziyon/ Position			
Somun / Wheel Nut		SOM-0332	
Model			

KM-80125

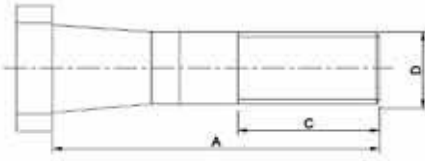

TEKNİK ÖZELLİKLER / TECHNICAL SPECIFICATION			
A(mm)	C (mm)	D (mm)	Kalite / Quality
85	53	M22x1.5	10.9
Org. No			
Poziyon/ Position		Ön / Front	
Somun / Wheel Nut		SOM-0141	
Model		KAMAZ	

KM-80126

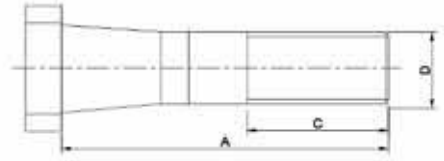

TEKNİK ÖZELLİKLER / TECHNICAL SPECIFICATION			
A(mm)	C (mm)	D (mm)	Kalite / Quality
106	63	M22x1.5	10.9
Org. No			
Poziyon/ Position		Arka / Rear	
Somun / Wheel Nut		SOM-0141	
Model		KAMAZ	

MZ-60125

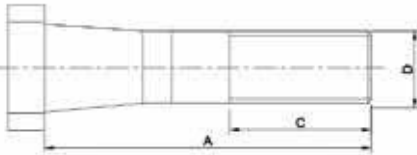

TEKNİK ÖZELLİKLER / TECHNICAL SPECIFICATION			
A(mm)	C (mm)	D (mm)	Kalite / Quality
90	50	M22x1.5	10.9
Org. No			
Poziyon/ Position		Ön / Front	
Somun / Wheel Nut		SOM-0141	
Model		MAZ-ÖN	

MZ-60126

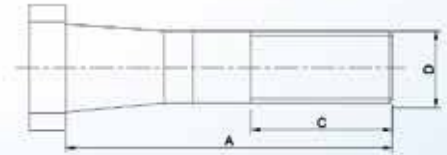

TEKNİK ÖZELLİKLER / TECHNICAL SPECIFICATION			
A(mm)	C (mm)	D (mm)	Kalite / Quality
105	50	M22x1.5	10.9
Org. No			
Poziyon/ Position		Arka / Rear	
Somun / Wheel Nut		SOM-0141	
Model		MAZ-ARKA	

DRS-30125

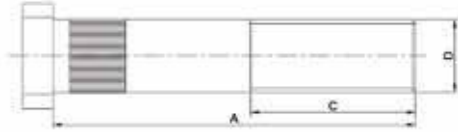

TEKNİK ÖZELLİKLER / TECHNICAL SPECIFICATION

A(mm)	C (mm)	D (mm)	Kalite / Quality
110	50	M22x1.5	10.9
Org. No			
Poziyon/ Position		Arka / Rear	
Somun / Wheel Nut		SOM-0241	
Model		OSMAN KOÇ - ÖZKOÇ - CEYLAN - SERTEL	

DRS-30126

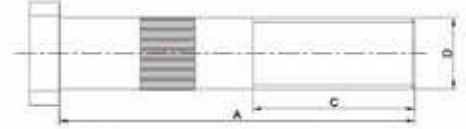

TEKNİK ÖZELLİKLER / TECHNICAL SPECIFICATION

A(mm)	C (mm)	D (mm)	Kalite / Quality
110	50	M22x1.5	10.9
Org. No			
Poziyon/ Position		Arka / Rear	
Somun / Wheel Nut		SOM-0241	
Model		OSMAN KOÇ - ÖZKOÇ - CEYLAN - SERTEL	

DRS-30127



TEKNİK ÖZELLİKLER / TECHNICAL SPECIFICATION

A(mm)	C (mm)	D (mm)	Kalite / Quality
110	50	M22x2	10.9
Org. No			
Poziyon/ Position		Arka / Rear	
Somun / Wheel Nut		SOM-0241	
Model		DORSE	

DRS-30128-1

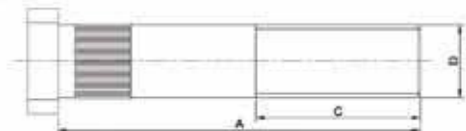

TEKNİK ÖZELLİKLER / TECHNICAL SPECIFICATION

A(mm)	C (mm)	D (mm)	Kalite / Quality
110	50	M22x1.5	10.9
Org. No			
Poziyon/ Position		Arka / Rear	
Somun / Wheel Nut		SOM-0141	
Model		OSMAN KOÇ - ÖZKOÇ - CEYLAN - SERTEL	

DRS-30129-1

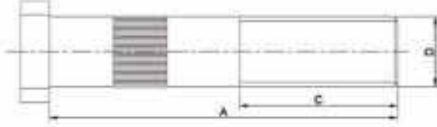

TEKNİK ÖZELLİKLER / TECHNICAL SPECIFICATION

A(mm)	C (mm)	D (mm)	Kalite / Quality
110	50	M22x1.5	10.9
Org. No			
Poziyon/ Position		Arka / Rear	
Somun / Wheel Nut		SOM-0141	
Model		OSMAN KOÇ - ÖZKOÇ - CEYLAN - SERTEL	

DRS-30144

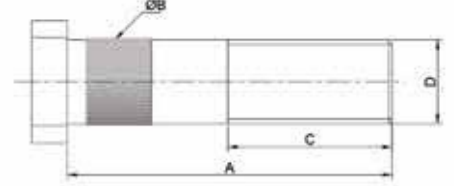

TEKNİK ÖZELLİKLER / TECHNICAL SPECIFICATION

A(mm)	C (mm)	D (mm)	Kalite / Quality
85	43	M22x2	10.9
Org. No			
Poziyon/ Position		Arka / Rear	
Somun / Wheel Nut		SOM-0141	
Model		PİLOT	

DRS-30145

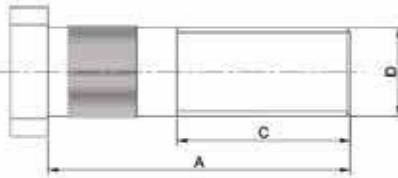

TEKNİK ÖZELLİKLER / TECHNICAL SPECIFICATION

A(mm)	C (mm)	D (mm)	Kalite / Quality
75	43	M22x1.5	10.9
Org. No			
Poziyon/ Position		Arka / Rear	
Somun / Wheel Nut		SOM-0141	
Model		PİLOT	

DRS-30146

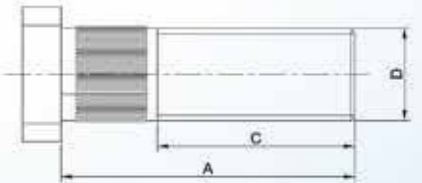

TEKNİK ÖZELLİKLER / TECHNICAL SPECIFICATION

A(mm)	C (mm)	D (mm)	Kalite / Quality
70	47	M22x1.5	10.9
Org. No			
Poziyon/ Position		Arka / Rear	
Somun / Wheel Nut		SOM-0140	
Model		ÖZKOÇ - SERTEL	

DRS-30147



TEKNİK ÖZELLİKLER / TECHNICAL SPECIFICATION

A(mm)	C (mm)	D (mm)	Kalite / Quality
90	43	M22x1.5	10.9
Org. No			
Poziyon/ Position		Arka / Rear	
Somun / Wheel Nut		SOM-0141	
Model		PİLOT	

DRS-30149



TEKNİK ÖZELLİKLER / TECHNICAL SPECIFICATION

A(mm)	C (mm)	D (mm)	Kalite / Quality
90	43	M22x1.5	10.9
Org. No			
Poziyon/ Position		Arka / Rear	
Somun / Wheel Nut		SOM-0141	
Model		SERİN - AYDIN	

DRS-30150

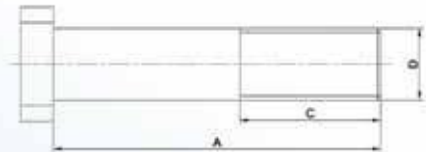

TEKNİK ÖZELLİKLER / TECHNICAL SPECIFICATION

A(mm)	C (mm)	D (mm)	Kalite / Quality
100	43	M22x1.5	10.9
Org. No			
Poziyon/ Position		Arka / Rear	
Somun / Wheel Nut		SOM-0141	
Model		SERİN - AYDIN	

DRS-30151

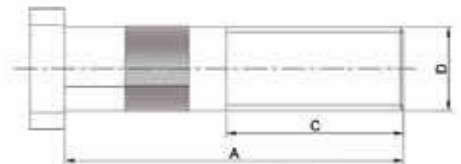

TEKNİK ÖZELLİKLER / TECHNICAL SPECIFICATION

A(mm)	C (mm)	D (mm)	Kalite / Quality
90	47	M22x1.5	10.9
Org. No			
Poziyon/ Position			
Somun / Wheel Nut		SOM-0141	
Model		SERTEL - ÖZKOÇ	

DRS-30152

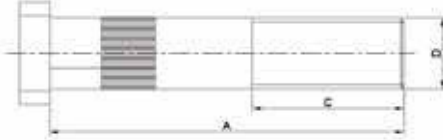

TEKNİK ÖZELLİKLER / TECHNICAL SPECIFICATION

A(mm)	C (mm)	D (mm)	Kalite / Quality
100	50	M22x1.5	10.9
Org. No			
Poziyon/ Position			
Somun / Wheel Nut		SOM-0141	
Model		SERTEL - ÖZKOÇ	

DRS-30153

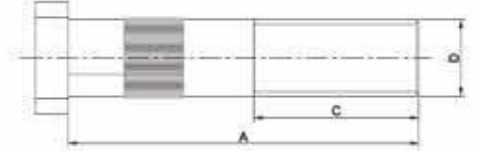

TEKNİK ÖZELLİKLER / TECHNICAL SPECIFICATION

A(mm)	C (mm)	D (mm)	Kalite / Quality
110	47	M22x1.5	10.9
Org. No			
Poziyon/ Position		Arka / Rear	
Somun / Wheel Nut		SOM-0141	
Model		ÖZKOÇ - SERTEL	

DRS-30155

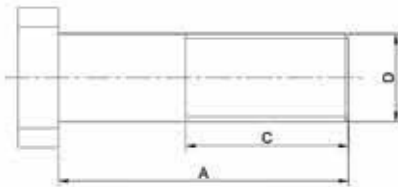

TEKNİK ÖZELLİKLER / TECHNICAL SPECIFICATION

A(mm)	C (mm)	D (mm)	Kalite / Quality
73	41	M22x1.5	10.9
Org. No			
Poziyon/ Position		Arka / Rear	
Somun / Wheel Nut		SOM-0140	
Model		SERİN - AYDIN	

DRS-30156



TEKNİK ÖZELLİKLER / TECHNICAL SPECIFICATION

A(mm)	C (mm)	D (mm)	Kalite / Quality
107	43	M22x1.5	10.9
Org. No			
Poziyon/ Position		Arka / Rear	
Somun / Wheel Nut		SOM-0141	
Model		SERİN - AYDIN	

APS-101

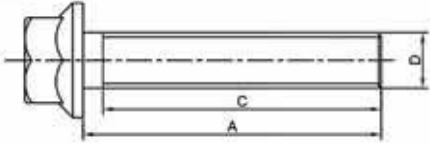

TEKNİK ÖZELLİKLER / TECHNICAL SPECIFICATION

A(mm)	C (mm)	D (mm)	Kalite / Quality
75	70	M14x1.5	10.9
Org. No			
Poziyon/ Position		Arka / Rear	
Somun / Wheel Nut			
Model		YILDIZ BAŞLI DİSK CİVATASI	

APS-102

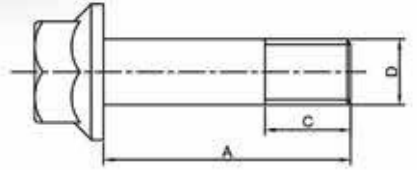

TEKNİK ÖZELLİKLER / TECHNICAL SPECIFICATION

A(mm)	C (mm)	D (mm)	Kalite / Quality
60	20.75	M16x1.5	10.9
Org. No			
Poziyon/ Position		Arka / Rear	
Somun / Wheel Nut			
Model		DİSK DENGELEYİCİ VİDA	

APS-103

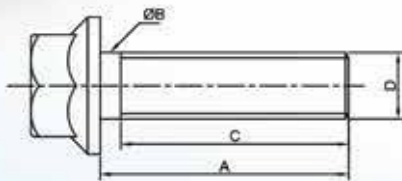

TEKNİK ÖZELLİKLER / TECHNICAL SPECIFICATION

A(mm)	C (mm)	D (mm)	Kalite / Quality
60	55	M16x1.5	10.9
Org. No			
Poziyon/ Position		Arka / Rear	
Somun / Wheel Nut			
Model		ANAHTAR BAŞLI DİSK CİVATASI	

APS-104

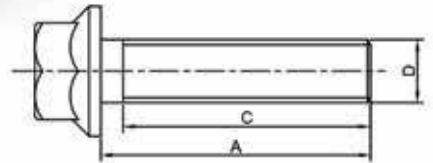

TEKNİK ÖZELLİKLER / TECHNICAL SPECIFICATION

A(mm)	C (mm)	D (mm)	Kalite / Quality
60	55	M14x1.5	10.9
Org. No		31796200	
Poziyon/ Position		Arka / Rear	
Somun / Wheel Nut			
Model		ANAHTAR BAŞLI DİSK CİVATASI	

APS-105



TEKNİK ÖZELLİKLER / TECHNICAL SPECIFICATION			
A(mm)	C (mm)	D (mm)	Kalite / Quality
75	18	M12x1.5	10.9
Org. No		3434366200	
Poziyon/ Position			
Somun / Wheel Nut			
Model		DİSK CİVATASI / SAF	

DRS-30301

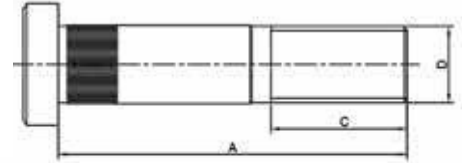

TEKNİK ÖZELLİKLER / TECHNICAL SPECIFICATION			
A(mm)	C (mm)	D (mm)	Kalite / Quality
90	42	M22x1.5	10.9
Org. No			
Poziyon/ Position		Arka / Rear	
Somun / Wheel Nut		SOM-0141	
Model		YTE	

DRS-30302

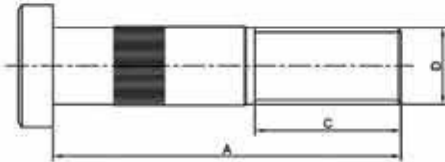

TEKNİK ÖZELLİKLER / TECHNICAL SPECIFICATION			
A(mm)	C (mm)	D (mm)	Kalite / Quality
100	42	M22x1.5	10.9
Org. No			
Poziyon/ Position		Arka / Rear	
Somun / Wheel Nut		SOM-0141	
Model		EFE	

DRS-30303

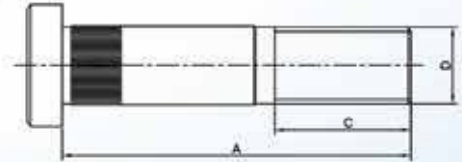

TEKNİK ÖZELLİKLER / TECHNICAL SPECIFICATION			
A(mm)	C (mm)	D (mm)	Kalite / Quality
100	39	M22x1.5	10.9
Org. No			
Poziyon/ Position		Arka / Rear	
Somun / Wheel Nut		SOM-0141	
Model		EFE	

DNF-10101

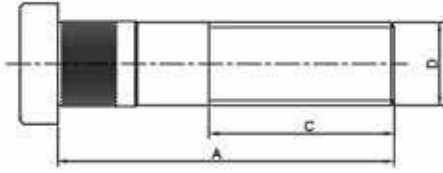

TEKNİK ÖZELLİKLER / TECHNICAL SPECIFICATION

A(mm)	C (mm)	D (mm)	Kalite / Quality
89	49	M22x1.5	10.9
Org. No		31796200	
Pozisyon/ Position		Arka / Rear	
Somun / Wheel Nut		SOM-0141	
Model		DONG FENG ÖN	

CBR-85110

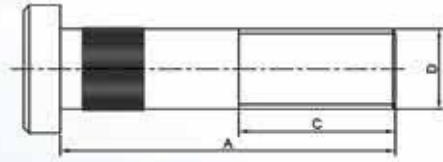

TEKNİK ÖZELLİKLER / TECHNICAL SPECIFICATION

A(mm)	C (mm)	D (mm)	Kalite / Quality
102	48	M22x1.5	10.9
Org. No			
Pozisyon/ Position		Arka / Rear	
Somun / Wheel Nut		SOM-0141	
Model			

DONG FENG - COBRA

DNF-10102

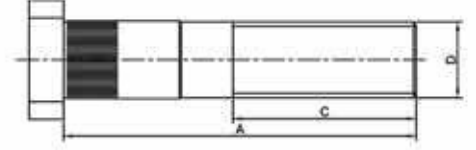

TEKNİK ÖZELLİKLER / TECHNICAL SPECIFICATION

A(mm)	C (mm)	D (mm)	Kalite / Quality
102	53	M22x1.5	10.9
Org. No			
Pozisyon/ Position		Arka / Rear	
Somun / Wheel Nut		SOM-0141	
Model		DONG FENG ARKA UZUN	

CBR-85111

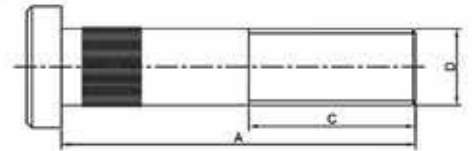

TEKNİK ÖZELLİKLER / TECHNICAL SPECIFICATION

A(mm)	C (mm)	D (mm)	Kalite / Quality
92	43	M22x1.5	10.9
Org. No			
Pozisyon/ Position		Arka / Rear	
Somun / Wheel Nut		SOM-0141	
Model			

TRM-0215

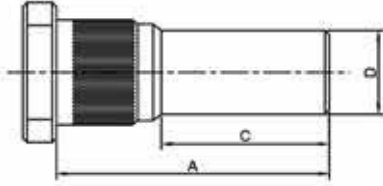

TEKNİK ÖZELLİKLER / TECHNICAL SPECIFICATION			
A(mm)	C (mm)	D (mm)	Kalite / Quality
65	40	M20x1.5	10.9
Org. No		31796200	
Poziyon/ Position			
Somun / Wheel Nut			
Model		HEMA	

TRM-0216

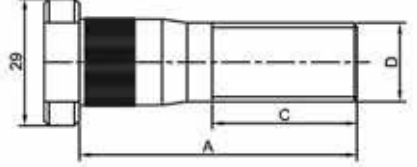

TEKNİK ÖZELLİKLER / TECHNICAL SPECIFICATION			
A(mm)	C (mm)	D (mm)	Kalite / Quality
60	33	M18x1.5	10.9
Org. No			
Poziyon/ Position			
Somun / Wheel Nut			
Model		HEMA	

TRM-0115

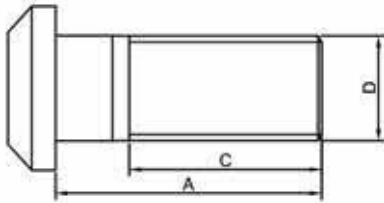

TEKNİK ÖZELLİKLER / TECHNICAL SPECIFICATION				
A(mm)	ØB (mm)	C (mm)	D (mm)	Kalite / Quality
56.5		40.5	W3/4"x16	10.9
Org. No		31796200		
Poziyon/ Position				
Somun / Wheel Nut		SOM-0310		
Model		RÖMORK BİJONU		

DRS-30190

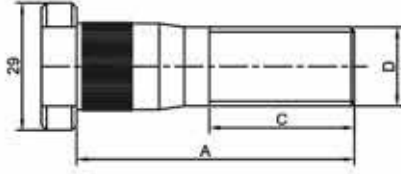

TEKNİK ÖZELLİKLER / TECHNICAL SPECIFICATION			
A(mm)	C (mm)	D (mm)	Kalite / Quality
76	33	M22x1.5	10.9
Org. No	A20630 / M003133		
Poziyon/ Position			
Somun / Wheel Nut	SOM-0140		
Model			

DRS-30192

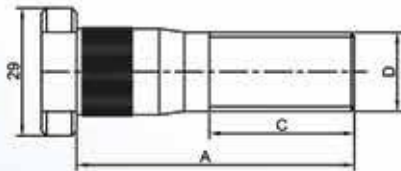

TEKNİK ÖZELLİKLER / TECHNICAL SPECIFICATION			
A(mm)	C (mm)	D (mm)	Kalite / Quality
106	39	M22x1.5	10.9
Org. No	A-FA0230		
Poziyon/ Position			
Somun / Wheel Nut	SOM-0141		
Model			

FRUEHAUF

DRS-30191

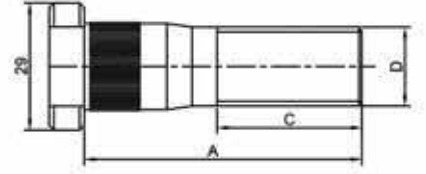

TEKNİK ÖZELLİKLER / TECHNICAL SPECIFICATION			
A(mm)	C (mm)	D (mm)	Kalite / Quality
90	39	M22x1.5	10.9
Org. No	A15613 / M006891		
Poziyon/ Position			
Somun / Wheel Nut	SOM-0141		
Model			

DRS-30193

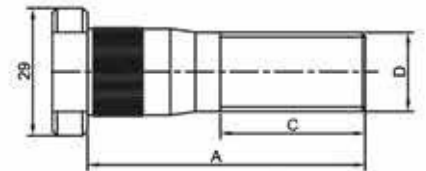

TEKNİK ÖZELLİKLER / TECHNICAL SPECIFICATION			
A(mm)	C (mm)	D (mm)	Kalite / Quality
74	38	M22x1.5	10.9
Org. No	M003133		
Poziyon/ Position			
Somun / Wheel Nut	SOM-0141		
Model			

SOM-0115



TEKNİK ÖZELLİKLER / TECHNICAL SPECIFICATION		
ORG.		
AA	H	D
19SW	20	M14x1.5
MODEL		

SOM-0120



TEKNİK ÖZELLİKLER / TECHNICAL SPECIFICATION		
ORG.	025219.1810 / 81.45503.0029 / 504356518	
AA	H	D
27SW	25	M18x1.5
MODEL	MAN 12-153, OTOKAR, DAİLY,RENAULT	

SOM-0130



TEKNİK ÖZELLİKLER / TECHNICAL SPECIFICATION		
ORG.		
AA	H	D
27SW	26	M20x1.5
MODEL	ATEGO,12-153	

SOM-0131



TEKNİK ÖZELLİKLER / TECHNICAL SPECIFICATION		
ORG.	0252192010 / 504071276 / 81455030030	
AA	H	D
30SW	26	M20x1.5
MODEL	EUROBUS, RENAULT	

SOM-0139



TEKNİK ÖZELLİKLER / TECHNICAL SPECIFICATION		
ORG.	7421303956/21303956/ 5000788677	
AA	H	D
33SW	32	M22x1.5
MODEL	DÖNER PULLU SOMUN	

SOM-0140



TEKNİK ÖZELLİKLER / TECHNICAL SPECIFICATION		
ORG.	041036367 / 81.45503.0026/ 385 400 01 24 / 02.5219.22.10/ 4 247 3012 00/0620 652/21203099	
AA	H	D
32SW	27	M22x1.5
MODEL	DÖNER PULLU SOMUN	

SOM-0141



TEKNİK ÖZELLİKLER / TECHNICAL SPECIFICATION		
ORG.	02.5219.23.10 / 1826 088 / 8.241.999.726 / 21218643	
AA	H	D
32SW	32	M22x1.5
MODEL	DÖNER PULLU SOMUN	

SOM-0143



TEKNİK ÖZELLİKLER / TECHNICAL SPECIFICATION		
ORG.		
AA	H	D
32SW	36	M22x1.5
MODEL	FATİH PROF. D.PULLU SOMUN	

SOM-0144



TEKNİK ÖZELLİKLER / TECHNICAL SPECIFICATION		
ORG.	0004011372 / 041032670 / 02.5219.33.10 / 1263 487 / 81.45503.0057	
AA	H	D
32SW	39	M22x1.5
MODEL	ALUMINIUM RIM NUT	

SOM-0145



TEKNİK ÖZELLİKLER / TECHNICAL SPECIFICATION			
ORG.	0252193410 / 1263488 / 0004011072 / 81455030055		
AA	H	D	
32SW	62	M22x1.5	
MODEL	ALUMINIUM RIM NUT		

SOM-0146



TEKNİK ÖZELLİKLER / TECHNICAL SPECIFICATION			
ORG.	20552688		
AA	H	D	
33SW	39	M22x1.5	
MODEL	ALUMINIUM RIM NUT		

SOM-0150



TEKNİK ÖZELLİKLER / TECHNICAL SPECIFICATION			
ORG.			
AA	H	D	
32SW	32	M22x2	
MODEL	DÖNER PULLU SOMUN		

SOM-0160



TEKNİK ÖZELLİKLER / TECHNICAL SPECIFICATION			
ORG.			
AA	H	D	
32SW	36	M24x1.5	
MODEL	FATİH PROF. D.PULLU SOMUN		

SOM-0162



TEKNİK ÖZELLİKLER / TECHNICAL SPECIFICATION			
ORG.			
AA	H	D	
36SW	36	M24x2	
MODEL	DÖNER PULLU SOMUN		

SOM-0169



TEKNİK ÖZELLİKLER / TECHNICAL SPECIFICATION			
ORG.	0243955		
AA	H	D	
33SW	27	7/8"-11BSF	
MODEL	DÖNER PULLU SOMUN		

SOM-0170



TEKNİK ÖZELLİKLER / TECHNICAL SPECIFICATION			
ORG.			
AA	H	D	
32SW	32	7/8"-11BSF	
MODEL	DÖNER PULLU SOMUN		

SOM-0171



TEKNİK ÖZELLİKLER / TECHNICAL SPECIFICATION			
ORG.			
AA	H	D	
32SW	39	7/8"-11BSF	
MODEL	SCANIA ALUMINIUM RIM NUT		

SOM-0172



TEKNİK ÖZELLİKLER / TECHNICAL SPECIFICATION			
ORG.			
AA	H	D	
32SW	62	7/8"-11BSF	
MODEL	SCANIA ALUMINIUM RIM NUT		

SOM-0179



TEKNİK ÖZELLİKLER / TECHNICAL SPECIFICATION		
ORG.	1083894	
AA	H	D
33SW	34	7/8"-14UNF
MODEL	VOLVO WHEEL NUT	

SOM-0180



TEKNİK ÖZELLİKLER / TECHNICAL SPECIFICATION		
ORG.		
AA	H	D
33SW	34	7/8"-14UNF
MODEL	VOLVO WHEEL NUT	

SOM-0181



TEKNİK ÖZELLİKLER / TECHNICAL SPECIFICATION		
ORG.		
AA	H	D
33SW	39	7/8"-14UNF
MODEL	VOLVO FH ALUMINIUM RIM NUT	

SOM-0182



TEKNİK ÖZELLİKLER / TECHNICAL SPECIFICATION		
ORG.		
AA	H	D
33SW	62	7/8"-14UNF
MODEL	VOLVO FH ALUMINIUM RIM NUT	

SOM-0211



TEKNİK ÖZELLİKLER / TECHNICAL SPECIFICATION		
ORG.		
AA	H	D
28SW	29	3/4"-16UNF
MODEL	HİDROMEK, JCB	

SOM-0220



TEKNİK ÖZELLİKLER / TECHNICAL SPECIFICATION		
ORG.		
AA	H	D
27SW	28	M18x1,5
MODEL	IVECO, 50NC TAKVİYELİ SOMUN	

SOM-0230



TEKNİK ÖZELLİKLER / TECHNICAL SPECIFICATION		
ORG.	0252141410	
AA	H	D
27SW	27	M20x1,5
MODEL	MERCEDES	

SOM-0240



TEKNİK ÖZELLİKLER / TECHNICAL SPECIFICATION		
ORG.		
AA	H	D
32SW	32	M22x1,5
MODEL	KISA TAKVİYELİ SOMUN	

SOM-0241



TEKNİK ÖZELLİKLER / TECHNICAL SPECIFICATION		
ORG.		
AA	H	D
30SW	32	M22x1,5
MODEL	KISA TAKVİYELİ SOMUN	

SOM-0242



TEKNİK ÖZELLİKLER / TECHNICAL SPECIFICATION			
ORG.			
AA	H	D	
32SW	40	M22x1,5	
MODEL	TAKVİYELİ SOMUN		

SOM-0250



TEKNİK ÖZELLİKLER / TECHNICAL SPECIFICATION			
ORG.			
AA	H	D	
32SW	40	M22x2	
MODEL	TAKVİYELİ SOMUN		

SOM-0270-R-L



TEKNİK ÖZELLİKLER / TECHNICAL SPECIFICATION			
ORG.			
AA	H	D	
32SW	32	7/8"-14UNF	
MODEL	TAKVİYELİ SOMUN		

SOM-0271-R-L



TEKNİK ÖZELLİKLER / TECHNICAL SPECIFICATION			
ORG.			
AA	H	D	
32SW	40	7/8"-14UNF	
MODEL	TAKVİYELİ SOMUN		

SOM-0320



TEKNİK ÖZELLİKLER / TECHNICAL SPECIFICATION			
ORG.	074361018205 / 06112220213		
AA	H	D	
24sW	24	M18x1,5	
MODEL	MAGIRUS,MB800		

SOM-0321



TEKNİK ÖZELLİKLER / TECHNICAL SPECIFICATION			
ORG.			
AA	H	D	
27SW	24	M18x1,5	
MODEL	IVECO,50NC		

SOM-0322



TEKNİK ÖZELLİKLER / TECHNICAL SPECIFICATION			
ORG.	659115300 / 0265447 / 0009901450/		
AA	H	D	
27SW	26	M18x2	
MODEL	MAN İSPİT		

SOM-0330



TEKNİK ÖZELLİKLER / TECHNICAL SPECIFICATION			
ORG.	074361020205 / 06112220215/ 001121798		
AA	H	D	
27SW	24	M20x1,5	
MODEL	MERCEDES		

SOM-0331-0332



TEKNİK ÖZELLİKLER / TECHNICAL SPECIFICATION			
ORG.			
AA	H	D	
30SW	27	M20x1,5	
MODEL	HİNO,KOMATSU		

SOM-0333



TEKNİK ÖZELLİKLER / TECHNICAL SPECIFICATION			
ORG.	659115304 / 3464015072 / 0612220416		
AA	H	D	
27SW	26	M20x2	
MODEL	VOLVO İSPİT		

SOM-0334



TEKNİK ÖZELLİKLER / TECHNICAL SPECIFICATION			
ORG.			
AA	H	D	
30SW	26	M20x2	
MODEL	VOLVO İSPİT		

SOM-0340



TEKNİK ÖZELLİKLER / TECHNICAL SPECIFICATION			
ORG.	074361022203		
AA	H	D	
27SW	26	M22x1,5	
MODEL	MERCEDES		

SOM-0341



TEKNİK ÖZELLİKLER / TECHNICAL SPECIFICATION			
ORG.	074361022205 / 06112220218		
AA	H	D	
30SW	24	M22X1,5	
MODEL	MAN,MERCEDES		

SOM-0342



TEKNİK ÖZELLİKLER / TECHNICAL SPECIFICATION			
ORG.			
AA	H	D	
30SW	27	M22X1,5	
MODEL	MAN,MERCEDES		

SOM-0450



TEKNİK ÖZELLİKLER / TECHNICAL SPECIFICATION			
ORG.	0326004100		
AA	H	D	
32SW	17	M22X1,5	
MODEL	SAF		

SOM-0451



TEKNİK ÖZELLİKLER / TECHNICAL SPECIFICATION			
ORG.			
AA	H	D	
32SW	17	M22X2	
MODEL	BPW		

SOM-0452



TEKNİK ÖZELLİKLER / TECHNICAL SPECIFICATION			
ORG.			
AA	H	D	
32SW	22	M22X2	
MODEL	BPW		

SOM-0455



TEKNİK ÖZELLİKLER / TECHNICAL SPECIFICATION			
ORG.			
AA	H	D	
38SW	22	M22X2	
MODEL	DAF		

SOM-D460



TEKNİK ÖZELLİKLER / TECHNICAL SPECIFICATION			
ORG.			
AA	H	D	
36SW	17	M22x1,5	
MODEL	MARATON		

ISB-AB02-R-L / ISB-AB03-R-L



TEKNİK ÖZELLİKLER / TECHNICAL SPECIFICATION			
ORG.			
AA	H	D	
23SW	22	M14X1,5	
MODEL	ISUZU NKR		

ISB-AB04-R-L



TEKNİK ÖZELLİKLER / TECHNICAL SPECIFICATION			
ORG.			
AA	H	D	
35SW	22	M16X1,5	
MODEL	ISUZU NKR55		

ISB-AB11-R-L



TEKNİK ÖZELLİKLER / TECHNICAL SPECIFICATION			
ORG.			
AA	H	D	
36SW	17	M25X1,5	
MODEL	ISUZU NPR		

ISB-AB12-R-L



TEKNİK ÖZELLİKLER / TECHNICAL SPECIFICATION			
ORG.			
AA	H	D	
30SW	16	M18X1,5	
MODEL	ISUZU NPR		

ISB-AB15-R-L / ISB-AB21-R-L



TEKNİK ÖZELLİKLER / TECHNICAL SPECIFICATION			
ORG.			
AA	H	D	
41SW	25	M20X1,5	
MODEL	ISUZU,MITSUBISHI		

ISB-AB16-R-L



TEKNİK ÖZELLİKLER / TECHNICAL SPECIFICATION			
ORG.			
AA	H	D	
41SW	25	M25X1.5	
MODEL	ISUZU ŞAMPİYON		

ISB-AB17-R-L / ISB-AB23-R-L



TEKNİK ÖZELLİKLER / TECHNICAL SPECIFICATION			
ORG.			
AA	H	D	
32SW	17	M22X1.5	
MODEL	ISUZU		

ISB-AB22-R-L / ISB-AB43-R-L



TEKNİK ÖZELLİKLER / TECHNICAL SPECIFICATION			
ORG.			
AA	H	D	
41SW	28	M30X1.5	
MODEL	ISUZU,MITSUBISHI		

ISB-AB33-R-L



TEKNİK ÖZELLİKLER / TECHNICAL SPECIFICATION			
ORG.			
AA	H	D	
41SW	25	M18x1.5	
MODEL	ISUZU NLR ÖN / FRONT		

ISB-AB34-R-L



TEKNİK ÖZELLİKLER / TECHNICAL SPECIFICATION			
ORG.			
AA	H	D	
41SW	25	M27x1.5	
MODEL	ISUZU NLR ARKA / REAR		

ISB-AB35-R-L



TEKNİK ÖZELLİKLER / TECHNICAL SPECIFICATION			
ORG.			
AA	H	D	
19SW	61	M18X1.5 M27x1.5	
MODEL	ISUZU NLR		

ISB-AB38-R/ISB-AB45-R/



TEKNİK ÖZELLİKLER / TECHNICAL SPECIFICATION			
ORG.			
AA	H	D	
21SW	64	M20X1.5 M30x1,5	
MODEL	ISUZU,MITSUBISHI		

ISB-AB42-R-L / MIT-AB29-R-L



TEKNİK ÖZELLİKLER / TECHNICAL SPECIFICATION			
ORG.			
AA	H	D	
41SW	25	M20X1.5	
MODEL	ISUZU,MITSUBISHI		

ISB-AB44-R-L



TEKNİK ÖZELLİKLER / TECHNICAL SPECIFICATION			
ORG.			
AA	H	D	
32SW	17	M22X1.5	
MODEL	ISUZU		

MIT-AB14-R-L



TEKNİK ÖZELLİKLER / TECHNICAL SPECIFICATION			
ORG.			
AA	H	D	
26SW	21	M16X1.5	
MODEL	MITSUBISHI / 304 / 515		

MIT-AB19-R-L / MIT-AB44-R-L



TEKNİK ÖZELLİKLER / TECHNICAL SPECIFICATION			
ORG.			
AA	H	D	
20SW	55	M19X1.5 M28x1.5	
MODEL	444-635-839-711 FUSO		

MIT-AB21-R-L / MIT-AB41-R-L



TEKNİK ÖZELLİKLER / TECHNICAL SPECIFICATION			
ORG.			
AA	H	D	
38SW	25	M19x1.5	
MODEL	444-635-839-711 FUSO		

MIT-AB22-R-L / MIT-AB42-R-L



TEKNİK ÖZELLİKLER / TECHNICAL SPECIFICATION

ORG.		
AA	H	D
38SW	25	M28x1.5
MODEL	444-635-839-711 FUSO	

MIT-AB23 / MIT-AB43



TEKNİK ÖZELLİKLER / TECHNICAL SPECIFICATION

ORG.		
AA	H	D
27SW	19	3/4"-16UNF
MODEL	MITSUBISHI	

MIT-AB27-R-L



TEKNİK ÖZELLİKLER / TECHNICAL SPECIFICATION

ORG.		
AA	H	D
21SW	64	M20X1.5 M30x1.5
MODEL	ISUZU,MITSUBISHI	

MIT-AB30-R-L



TEKNİK ÖZELLİKLER / TECHNICAL SPECIFICATION

ORG.		
AA	H	D
41SW	28	M30X1.5
MODEL	ISUZU,MITSUBISHI	

MIT-AB31



TEKNİK ÖZELLİKLER / TECHNICAL SPECIFICATION

ORG.		
AA	H	D
27SW	19	3/4"-16UNF
MODEL	MITSUBISHI	

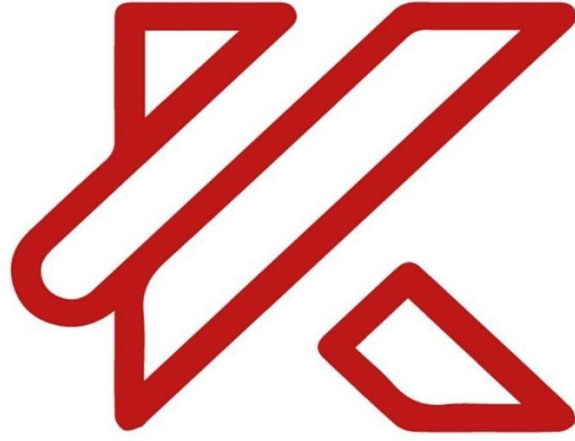

KUTLU TRUCK

www.kutlutruck.com

+90 (362) 238 11 60



info@kutlutruck.com



+90 (545) 465 55 53



+90 (546) 465 55 53

İstiklal Mahallesi Atatürk Bulvarı No:155
Tekkeköy / Samsun / Türkiye

